



JSC GROUP

Interiors Ltd.



DUET



SOMFY



DISTINCTION



FOLIO



QUANTUM

Avant-garde.

Version 5.6

www.jsc.group

Orchard House - 15 Commerce Way - Colchester - CO2 8HH
Tel. 01206 877640 - Fax. 01206 797200 - Email. sales@jsc.group

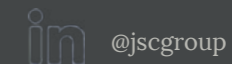

OUR CLIENT CARE TEAM

The story begins in 1978, in the small town of Deeping St. James, Lincolnshire, when a window dressing hardware store was founded by John Sellars and his wife, Linda. (John Sellars & Co. is now known as JSC Group Interiors Ltd).

Over forty years have now passed and they have been privileged to be a part of over *sixty thousand* residential and commercial projects so far, with a team dedicated to provide quality of service and product.

They offer a bespoke service tailored to their clients needs, with most of their product offerings being made-to-measure 'Window Dressing' hardware.

Since 1978.



Olly Pittman
Managing Director



Stuart Spilling
Sales Manager



Chris Aldous
Production Manager



Jade Pittman
Marketing Co-ordinator



Jayne Webber
Sales Administration



Jo Saunders
Office & Customer Service Manager



Sarah Saunderson
Special Projects Executive

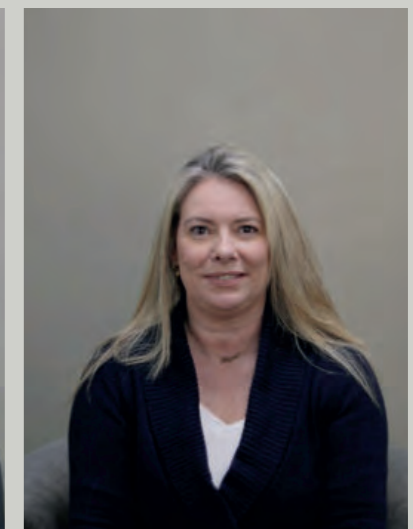

Abigail Bareham
Accounts

Contents.



Distinction

Distinction 28 Corded	8
Distinction 28 Uncorded	9
Distinction 34 Corded	16
Distinction 34 Uncorded	17
Distinction 20 Uncorded	20

Somfy

Motorised Tracks	28
Motorised Roman Headrails	29

Quantum

MTM Roman Headrails	33
Stonehouse Corded	36
Painswick Corded	37
Berkeley Corded	38
Broadway Corded	39
Stonehouse Uncorded	40
Painswick Uncorded	41
Berkeley Uncorded	42
Broadway Uncorded	43
Mini Broadway Uncorded	44
Burford Uncorded	44
The Curve Uncorded	45

Duet

Duet Wood Poles	50-51
-----------------	-------

Avant-garde

Avant-garde Wood Poles	52-53
------------------------	-------

Folio

Folio Wood Poles	54-60
Basswood Venetians	61



Credit: Broomfield Interiors



This is the most showcased pole of the flagship collection. The Distinction 28 is a simple and stylish profile that can comfortably hold medium to heavy weight curtains.

Distinction 28 is perfect for bay windows and bi-fold doors, as the curtains do not conflict with the brackets; allowing for ease of traverse for the curtains.

Available in eleven finishes from heritage shaded white, to a warm antique bronze.

Distinction 28.

Distinction 28 Corded

Medium - Heavy Duty



Left: D28C shown in Light Gray

Below: D28C shown in Antique Bronze



Distinction 28 Uncorded

Heavy Duty

Top: D28U shown in Black Sheen

Left: D28U shown in Silver Sheen

Right: D28U shown in Shaded White

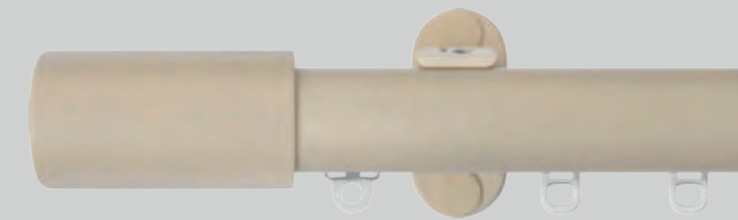

Profile



COMPATIBLE WITH
SURE

Pole Diameter: 28mm
Forward and Reverse Bends: 25cm radius
Surf & Surf Roller Gliders: 60 and 80mm spacing
Gradual Curves: Greater than 1m radius
Maximum Length (in one piece): 6m

Can be corded from both sides using the intermediate pulley which will increase the weight carrying capacity of the pole.

Efficient nylon gliders as standard, with the option of rollers. Double overlap arms allow the curtains to remain well-dressed when open.

Discreet top/ceiling fix brackets available.
Strong face fixed wall 'T' bracket with depth adjustment (see page 24).
Option of standard or long wall brackets at no extra cost.

Profile



COMPATIBLE WITH
SURE

Pole Diameter: 28mm
Forward and Reverse Bends: 25cm radius
Surf & Surf Roller Gliders: 60 and 80mm spacing
Gradual Curves: Greater than 1m radius
Maximum Length (in one piece): 6m

Efficient nylon gliders as standard, with the option of rollers. Double overlap arms allow the curtains to remain well-dressed when open.

Discreet top/ceiling fix brackets available.
Strong face fixed wall 'T' bracket with depth adjustment (see page 24).
Option of standard or long wall brackets at no extra cost.





Credit: Interior Fashion
@interiorfashionltd

Distinction 28 Finials

The end cap finial comes as standard on uncorded Distinction poles, with the option of either sphere or barrel finials. Corded Distinction poles have the barrel finial as part of the cording endset, with the option of sphere finials in addition if required.



Sphere Finial

Optional on Corded and Uncorded poles.



Barrel Finial

Standard on Corded poles, optional on Uncorded.



End Cap Finial

Standard on Uncorded poles.

Distinction Brackets

Distinction poles can be either face/wall fixed or top/ceiling fixed. The adjustable face/wall brackets allow ease of fitting - the 'T' brackets are mounted to the wall first and then the adjustable arms (which come already fitted to the pole), can be slid into the backplates. If necessary, the bottom of the face fixed back plate can be modified so that the bracket is reduced to 3cm in height.



Face/Wall Fix



Top/Ceiling Fix



With a narrow and rectangular profile, the Distinction 34 offers a sleek accent to a window dressing.

The Distinction collection is perfect for bay windows and bi-fold doors, as the curtains do not conflict with the brackets; allowing for ease of traverse for the curtains.

Distinction 34.

Distinction 34 Corded

Medium Duty



- Top:** D34C shown in Steel Sheen
- Left:** D34C shown in Antique Bronze
- Below:** D34C shown in Hammered Steel



Distinction 34 Uncorded

Heavy Duty

- Top:** D34U shown in Californian Gold
- Left:** D34U shown in Black Sheen
- Below:** D34U shown in Silver Sheen

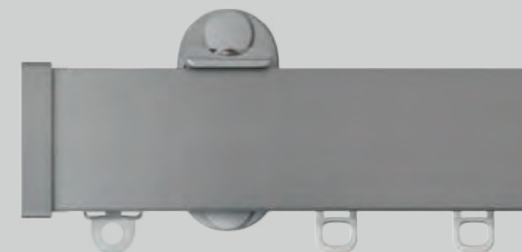

Profile



COMPATIBLE WITH
SURF

- Track Height:** 34mm
- Forward and Reverse Bends:** 21cm radius
- Surf & Surf Roller Gliders:** 60 and 80mm spacing
- Gradual Curves:** Greater than 1m radius
- Maximum Length (in one piece):** 6m

Efficient nylon gliders as standard, with the option of rollers.
Double overlap arms allow the curtains to remain well-dressed when open.

Discreet top/ceiling fix brackets available.
Strong face fixed wall 'T' bracket with depth adjustment (see page 24).
Option of standard or long wall brackets at no extra cost.

No intermediate pulley is available for the Distinction 34.

Profile



COMPATIBLE WITH
SURF

- Track Height:** 34mm
- Forward and Reverse Bends:** 21cm radius
- Surf & Surf Roller Gliders:** 60 and 80mm spacing
- Gradual Curves:** Greater than 1m radius
- Maximum Length (in one piece):** 6m

Efficient nylon gliders as standard, with the option of rollers.
Double overlap arms allow the curtains to remain well-dressed when open.

Discreet top/ceiling fix brackets available.
Strong face fixed wall 'T' bracket with depth adjustment (see page 24).
Option of standard or long wall brackets at no extra cost.



The Distinction 20 is a slim and discreet pole, perfect for voiles. It is often used as the rear pole on a double pole system.

Distinction 20 poles are only available as uncorded.

Distinction 20.

Distinction 20 Uncorded

Heavy Duty

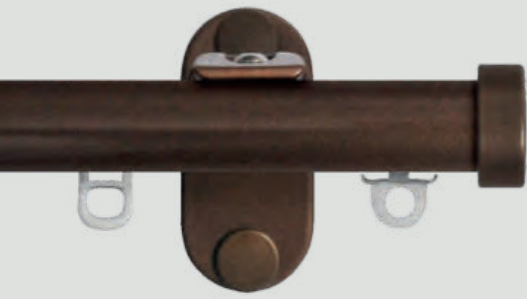

Top: D20U shown in Antique Bronze

Left: D20U shown in Silver Sheen

Below: D20U shown in Light Gray

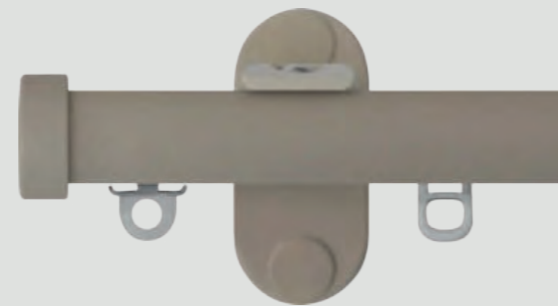

Credit: Delia Interiors
www.deliainteriors.com

Profile



COMPATIBLE WITH
SURF

Pole Diameter: 20mm
Forward and Reverse Bends: 20cm radius
Surf & Surf Roller Gliders: 60 and 80mm spacing
Gradual Curves: Greater than 1m radius
Maximum Length (in one piece): 6m

Often used as the rear pole as part of a double system.

Efficient nylon gliders as standard, with the option of rollers.

Discreet top/ceiling fix brackets available.
Strong face fixed wall 'T' bracket with depth adjustment (see page 24).
Option of standard or long wall brackets at no extra cost.

Double Pole System

For a stylish finish that still maintains privacy, consider a double curtain pole system. These systems can be used with angle bends and gradual curves.

Typically, the front pole holding the fuller curtains is created from the Distinction 28, with the slimmer Distinction 20 as the rear pole.

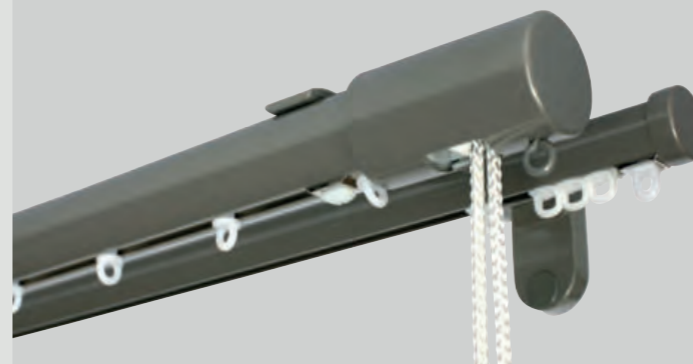

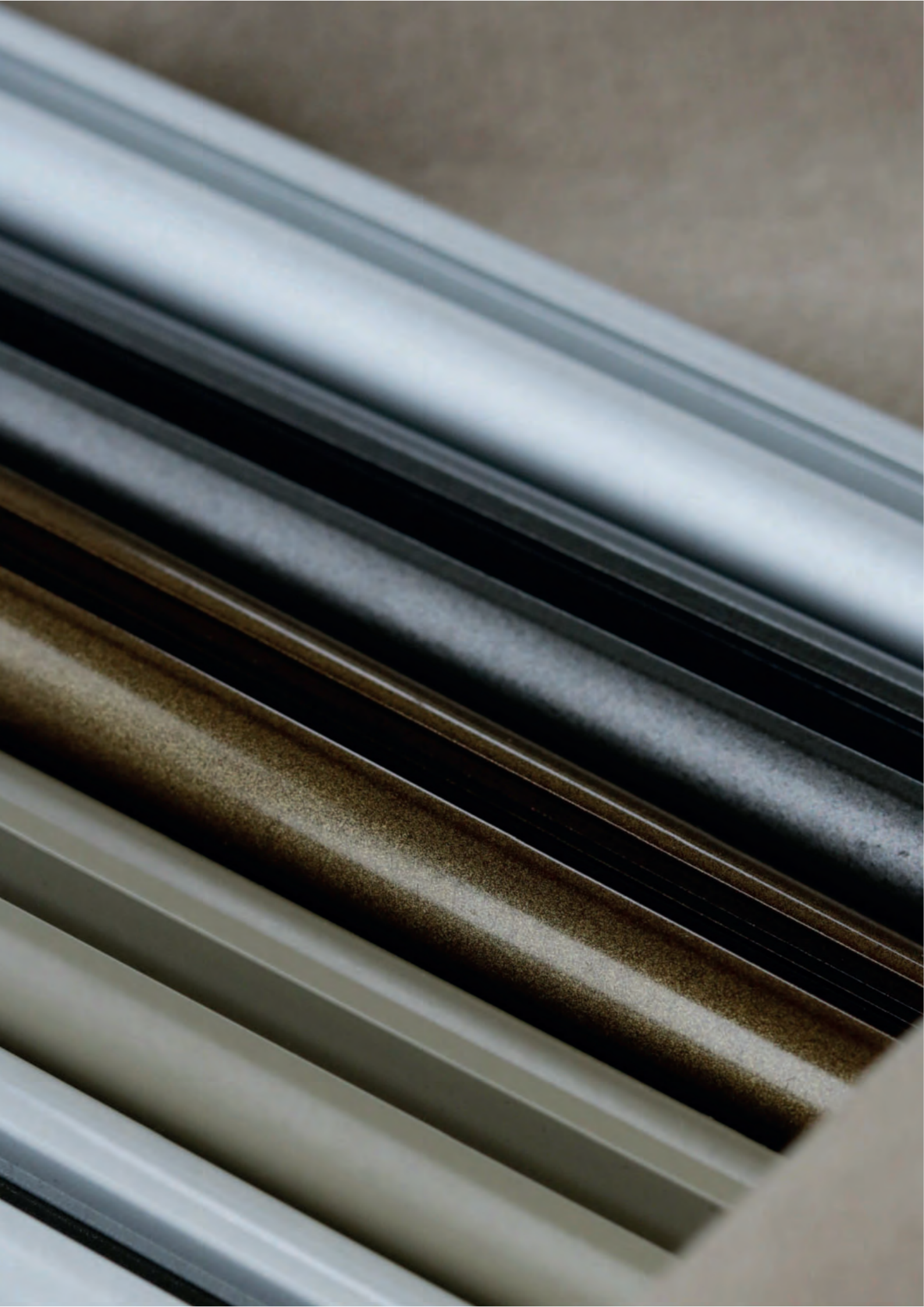

White Sheen



Silver Sheen

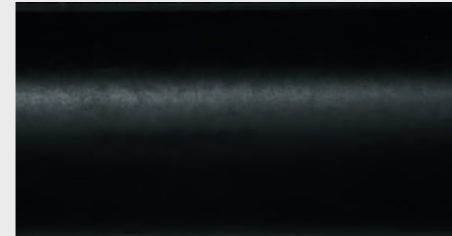

Black Sheen



Country Cream

Price Group 1

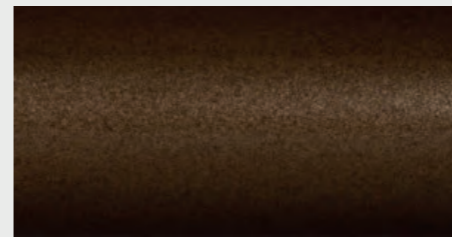

Californian Gold



Steel Sheen

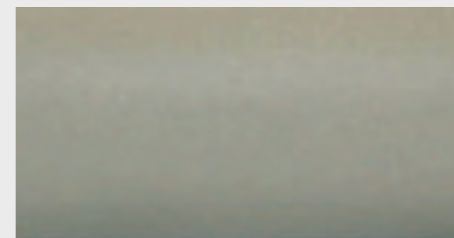

Dove Gray

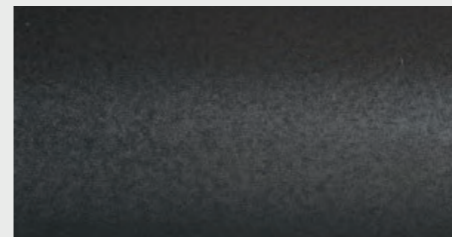

Hammered Steel

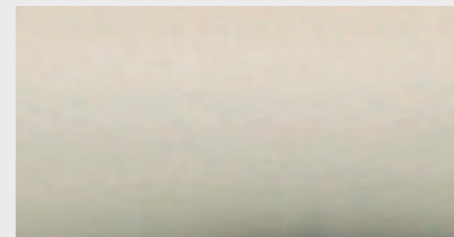

Shaded White

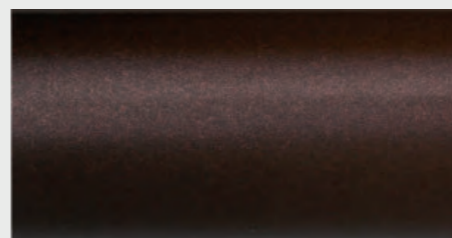

Antique Bronze

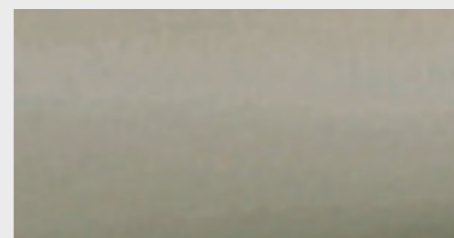

Light Gray

Price Group 2



Credit: Sew Sew Pretty | www.sewsewpretty.com

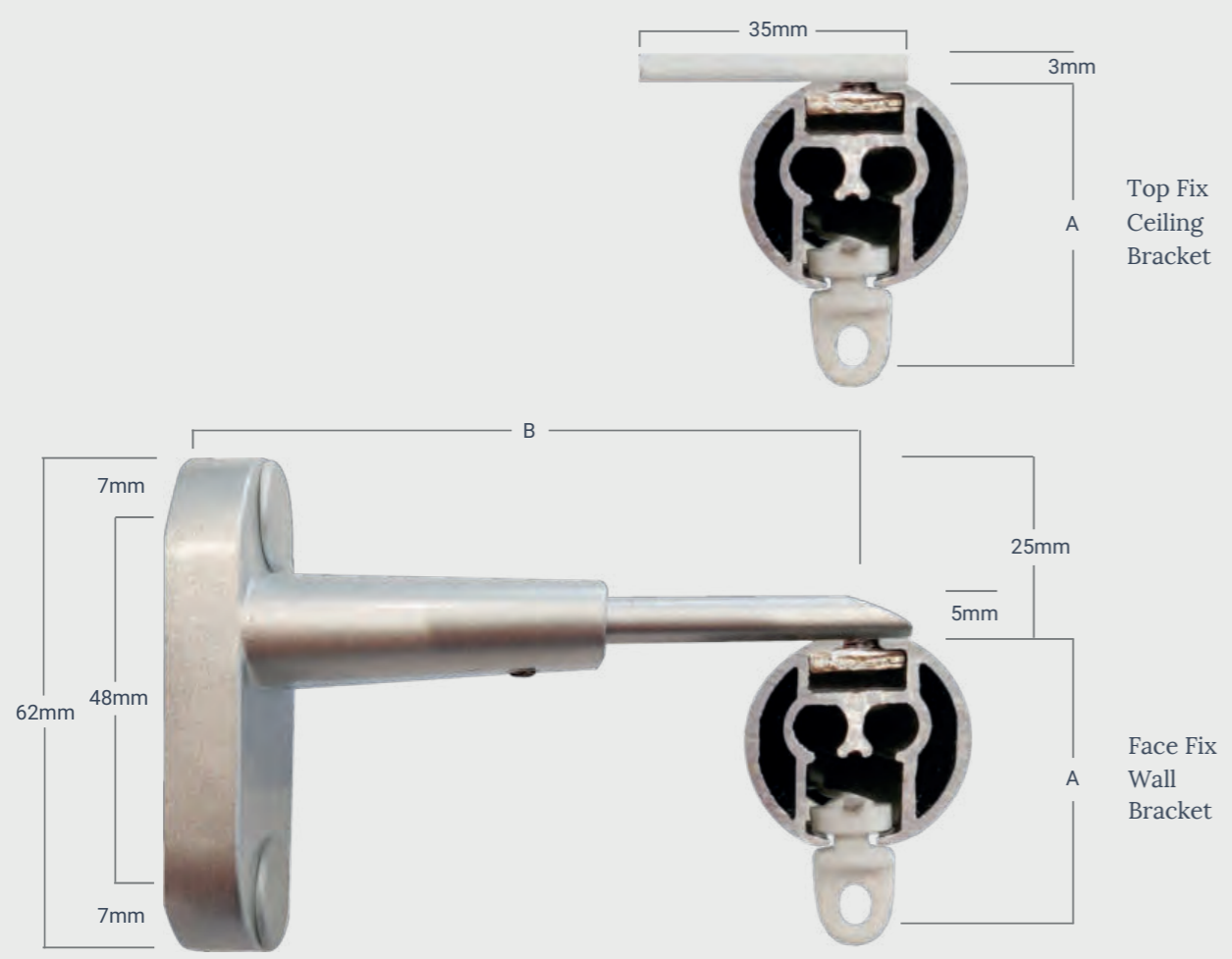

	D28	D34	D20
A: Top of the pole to eye of the glider			
Standard Glider	33mm	41mm	24mm
Surf Glider	37mm	45mm	28mm
Roller Glider	33mm	43mm	26mm
Surf Roller Glider	38mm	46mm	29mm

Wall Brackets (40mm depth adjustment as standard)	Standard Adjustable Bracket	Long Adjustable Bracket (use for double system)
B: Wall to centre of pole	75 - 115mm	140 - 180mm
C: Distance between front and back poles on double pole system	N/A	70mm*

*This bracket can be modified to allow for Surf 60 to be used on the front and rear pole upon request

These measures are an indication and could be subject to change if there are component supply issues etc. We strongly recommend that the poles are fitted and measurements taken before the curtains are made.



D34 recess bracket (uncorded only)



D28 recess bracket (uncorded only)



D28 connecting bridge and optional colour matched cover

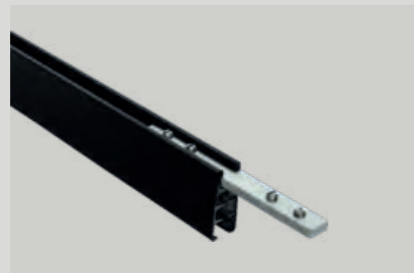

D34 connecting bridge (no cover available)



D28 intermediate pulley including colour matched cover - this increases the weight carrying capacity of the pole.





Glydea

A premium and discreet solution for luxury properties, with ultra quiet operation. Key functions include touch motion.

- Curtains up to 60 kg, max. track length 10m
- Silent mode <38 dB(A)
- Straight, bent or gradual curved track
- Rollers as standard or Roller Surf 60/ 80mm
- Left or right-side motor



Movelite (Wirefree)

A versatile motor, accessible to all at a competitive entry level price point. Key functions include touch motion.

- Curtains up to 35kg, max. track length 6m
- Available as a straight track only
- Rollers as standard or Roller Surf 60/ 80mm
- Left or right-side motor

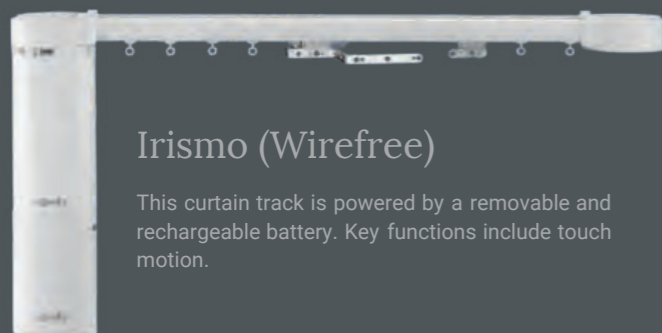

Irisimo (Wirefree)

This curtain track is powered by a removable and rechargeable battery. Key functions include touch motion.

- Curtains up to 45 kg, max. track length 10m
- Straight, bent or gradual curved track
- Rollers as standard or Roller Surf 60/ 80mm
- Left or right-side motor



Movelite

A mains powered, compact solution, offering effortless curtain motorisation. Key functions include touch motion.

- Curtains up to 35kg, max. track length 6m
- Straight, bent or gradual curved track
- Rollers as standard or Roller Surf 60/ 80mm
- Left or right-side motor



- Wall switch: Smoove RTS
- Remote control: Situo RTS
- App control: TaHoma@
- Voice control: Compatible with Amazon Alexa and Google Assistant

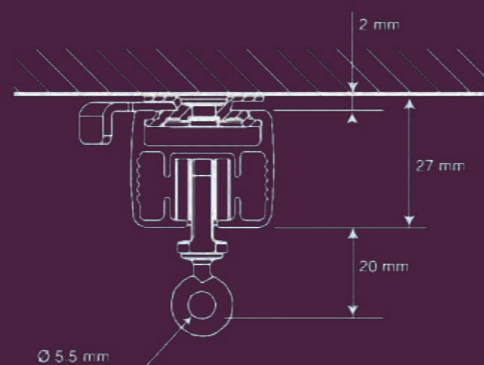
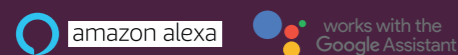

MTM Motorised Roman Headrails

Motor Upgrades

Max. capacity is 4.5 kg / Min. width is 50cm



Tilt & Lift 25 WF RTS
Compatible with all Somfy RTS handsets and wall switches.



Motor with Mains Adaptor



Motor with Rechargeable Lith-ion



Wirefree Li-ion Solar Panel and Rechargeable Battery

Further upgrades for medium to large residential and commercial roman blinds



Sonesse 30 Wirefree (Li-ion) RTS Motor
Ultra silent motor with built-in rechargeable battery.



Mains Powered Sonesse 40
Quiet and strong. RTS, wired and RS485 integrated network options.

Somfy compatible with Home Automation Systems Including:



Please contact us to find out if another smart home automation system will be compatible

Additional Components



Single Channel Remote



5 Channel Remote



Telis Chronis 6 Timer



Telis 16



Tahoma Switch Hub



Smoove Origin 1 RTS + Frame (White)

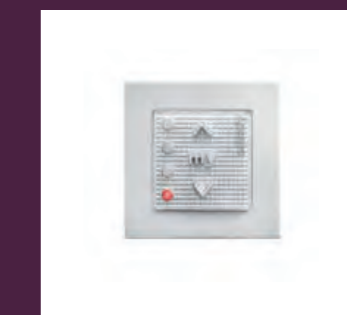

Smoove Origin 4 RTS + Frame (White)



Lith-ion Battery Charger



Credit: Lisa Dawson
www.lisadawson.co.uk



Made-to-Measure Child Safe Roman Headrail

Roman Blind Systems and Kits - Compliant with the child safety blind regulations BS EN13120:2009 + A1:2014

Child Safety

All made-to-measure blinds are supplied with cord adjusters and breakaway safety 'handbag' clips as standard. The blind cords at the rear of the blinds will need to be secured with the cord adjusters that are supplied with each blind.

If you wish to tie a knot underneath these to prevent call backs, then please sew the breakaway 'handbag clips' to the bottom two rod pockets of the blind. Any necessary child safety devices and labelling are supplied.

5 Year Warranty

The 5 year warranty covers parts or replacement only, and is valid when the blind attached to it is within the specified weight limits. It does not cover the inadvertent activation of the child safety devices.

Chain Colour

We offer metal chains in chrome, brass, grey nickel, bronze, black nickel and antique brass finishes. We can also provide white plastic chain in set sized loops.

Ordering

Please specify the fitting height and blind drop - the chain needs to be a minimum of 60cm from the floor - **it doesn't need securing with the breakaway gear in play**. White chain is available in set size loops only, so the nearest size will be used.

Specification

10kg blind weight capacity - 1:4 Ratio
3.5kg blind weight capacity - 1:1 Ratio
3m of cord on cord drums



Credit: Kate Tiffin
Credit: Andrew Taylor

Featuring: Extra heavy duty Stonehouse
corded track in white

Stonehouse Extra Heavy Duty Corded

Extra heavy duty corded track which will take curtains up to 80kg. The curved styling makes it a very attractive option where heavy Surf curtains or long drops are required.

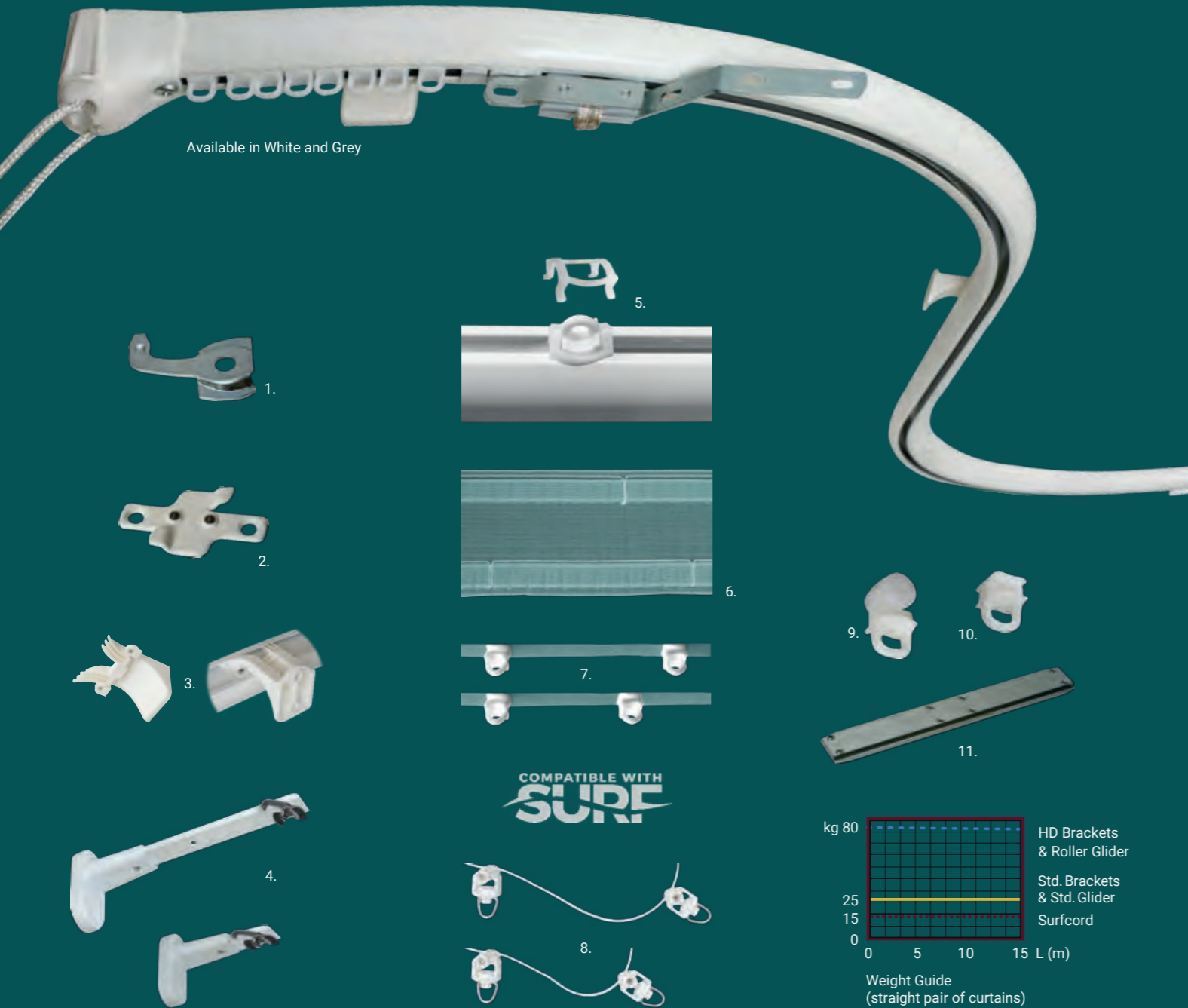

Available in White and Grey

Painswick Heavy Duty Corded

A track with large roller gliders and enclosed cord channels enabling it to be forward and reverse bent - excellent for bay windows and heavy curtains.

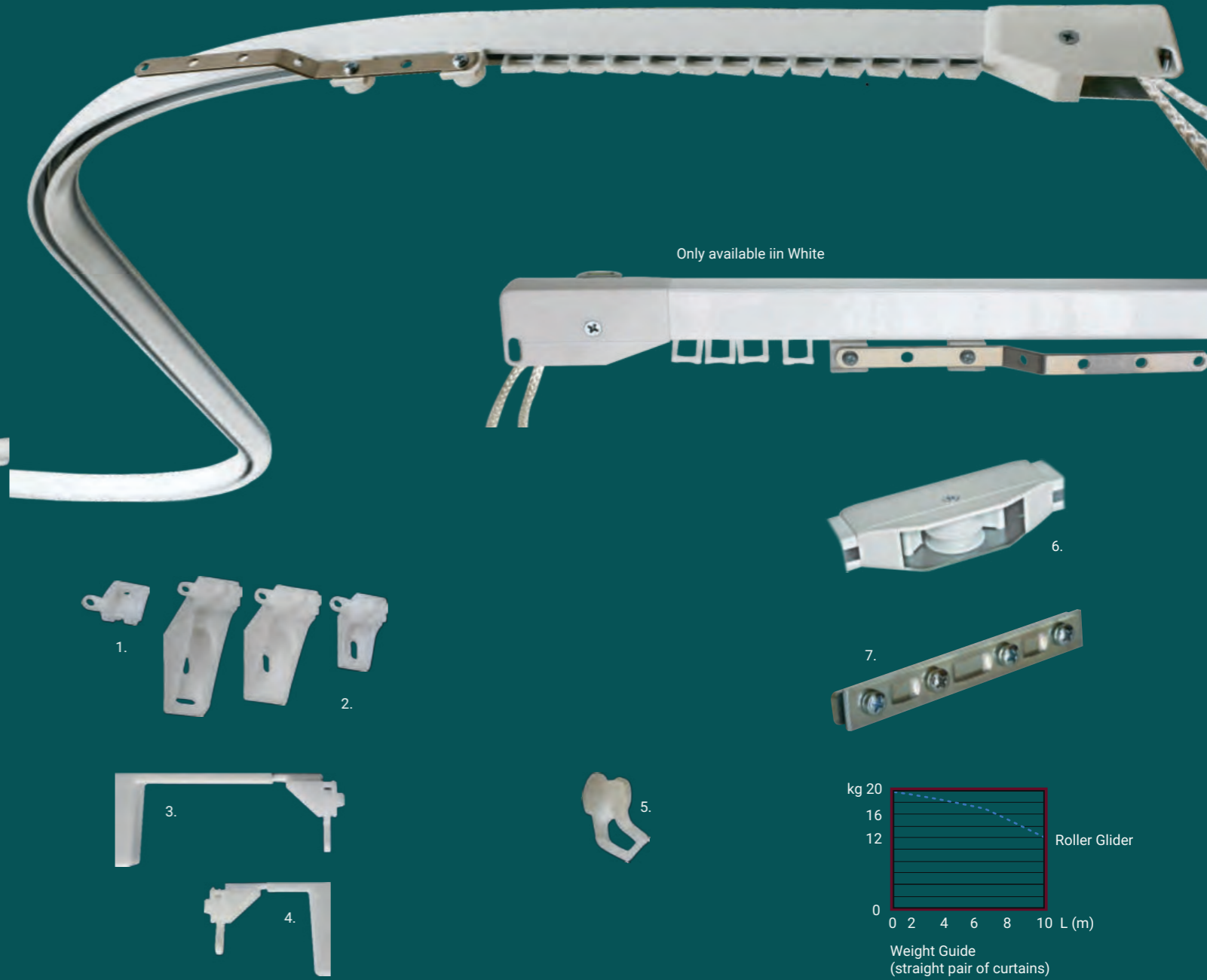

Only available in White

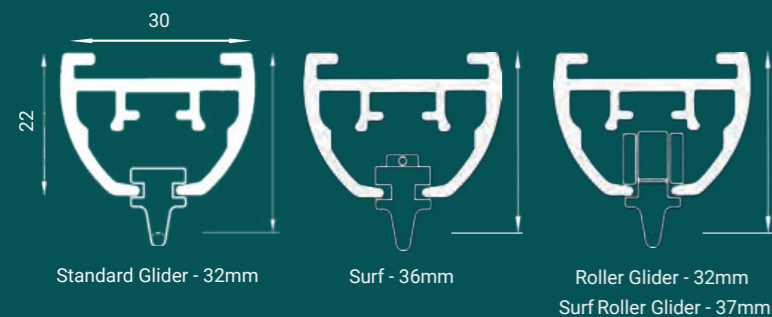

- 1. ST/TF Top Fix Clamp - up to 25kg
- 2. ST/HDTF Heavy Duty Top Fix Clamp - up to 80kg
- 3. ST/FFW/40 Face Fix Bracket - up to 25kg
- 4. ST/SAB Standard Adjustable Bracket 88 - 128mm
- 5. ST/LAB Long Adjustable Bracket 140 - 180mm
- 6. SUR/BRAKE Surf Brake
- 7. SUR/TAPE Surf Heading Tape
- 8. SUR/80 & SUR/60 Surf 80mm/60mm Glider Ribbon
- 9. SRO/80 & SRO/60 Surf 80mm/60mm Roller Gliders
- 10. ST/RG Roller Glider
- 11. WCG Wide Channel Glider
- 12. ST/CB Connecting Bridge

Std. radius 30cm
Forward • Reverse • Gradual



- 1. LLTF Top Fix Leverlock Bracket
- 2. LLUF/42-66-84 3 sizes of Universal Leverlock Brackets
- 3. TRA/LBKTCOV Face Fixed L Bracket & Cover - Long 10.7cm
- 4. TRA/SBKTCOV Face Fixed L Bracket & Cover - Standard 6.5cm
- 5. BP/RG Roller Glider
- 6. BP/I Intermediate Pulley
- 7. BP/CB Connecting Bridge

Std. radius 18cm
Forward • Reverse • Gradual

Berkeley Medium-Heavy Duty Corded

A track with enclosed cord channels, enabling it to be forward and reverse bent - perfect for bay windows. The Berkeley corded can be operated from one side or both sides using an intermediate pulley.

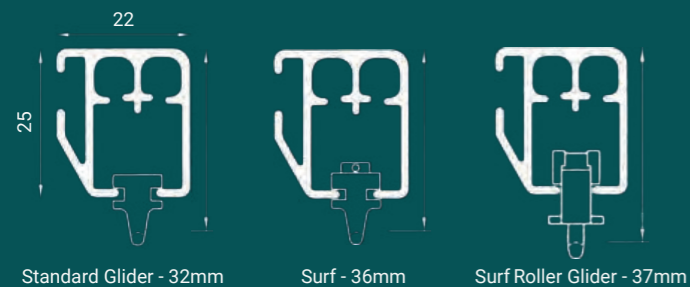
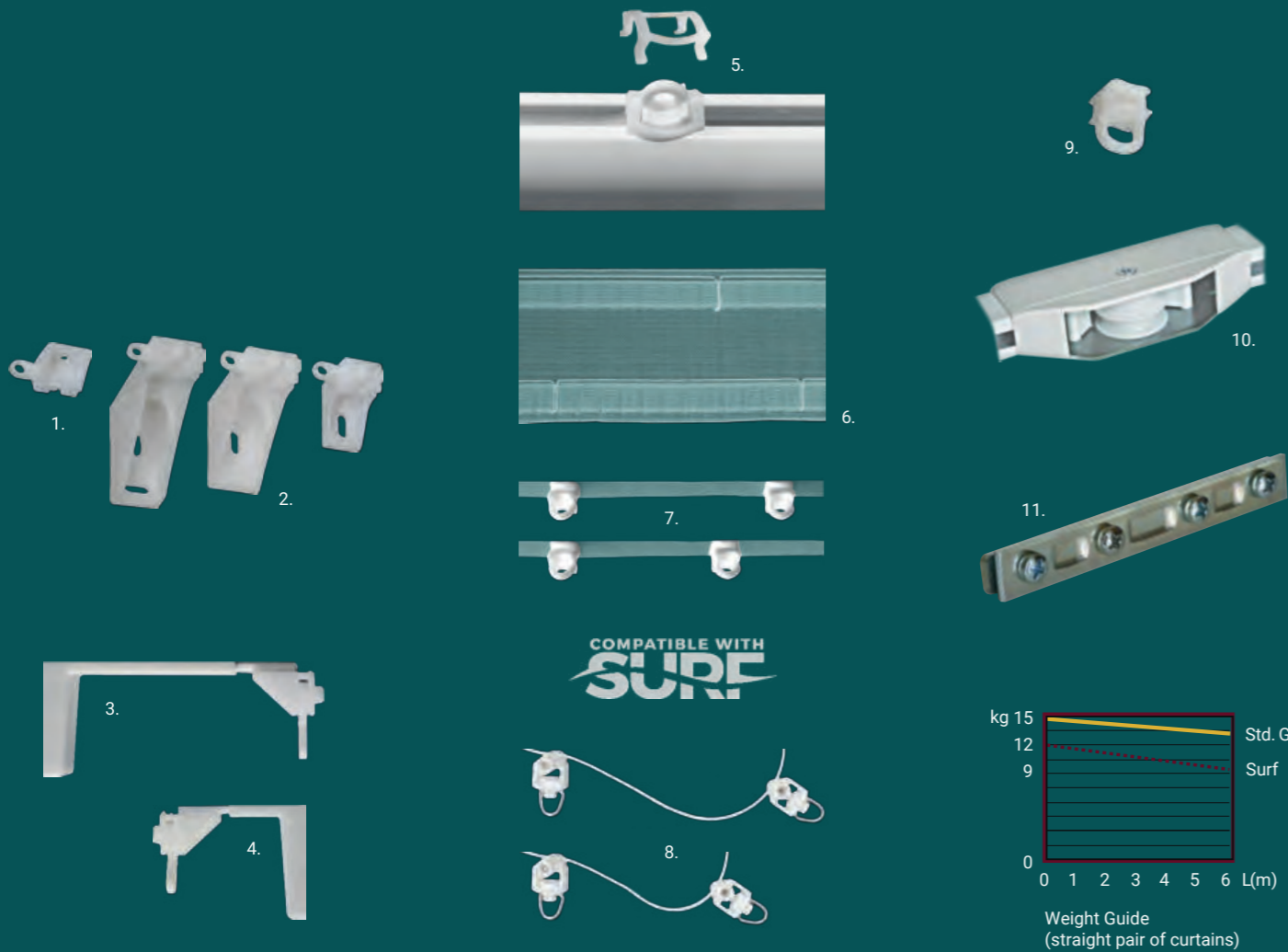

1. LLTF Top Fix Leverlock Bracket
2. LLUF/42-66-84 3 sizes of Universal Leverlock Brackets
3. TRA/LBKTCOV Face Fixed L Bracket & Cover - Long 10.7cm
4. TRA/SBKTCOV Face Fixed L Bracket & Cover - Standard 6.5cm
5. SUR/BRAKE Surf Brake
6. SUR/TAPE Surf Heading Tape
7. SU/80 & SU/60 Surf 80mm/ 60mm Glider Ribbon
8. SRO/80 & SRO/60 Surf 80mm/ 60mm Roller Gliders
9. WCG Wide Channel Glider
10. BP/I Intermediate Pulley
11. BP/CB Connecting Bridge

Std. radius 18cm
Forward • Reverse • Gradual

Broadway Medium Duty Corded

This track can be forward and reverse bent and therefore perfect for bay windows. Operation for the corded Broadway can be from one or both sides when using an intermediate pulley.

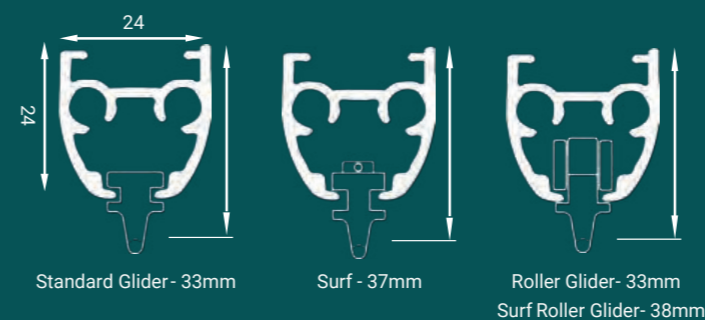
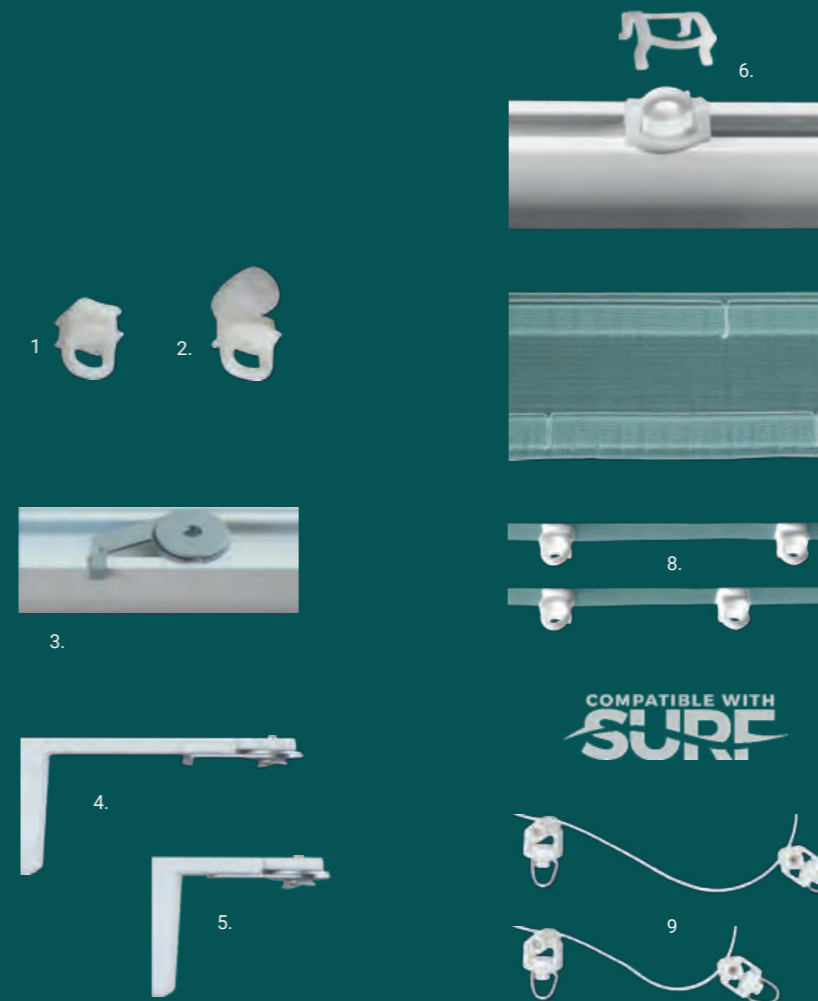

1. WCG Wide Channel Glider
2. BR/RG Roller Glider
3. BR/TF Top Fix Clamp
4. TRA/LBKTCOV Face Fixed L Bracket & Cover - Long 8cm
5. TRA/SBKTCOV Face Fixed L Bracket & Cover - Standard 3.8cm
6. SUR/BRAKE Surf Brake
7. SUR/TAPE Surf Heading Tape
8. SU/80 & SU/60 Surf 80mm/ 60mm Glider Ribbon
9. SRO/80 & SRO/60 Surf 80mm/ 60mm Roller Gliders
10. BP/I Intermediate Pulley

Std. radius 20cm
Forward • Reverse • Gradual

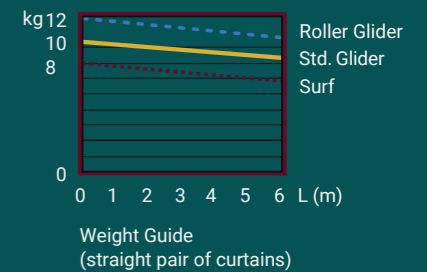
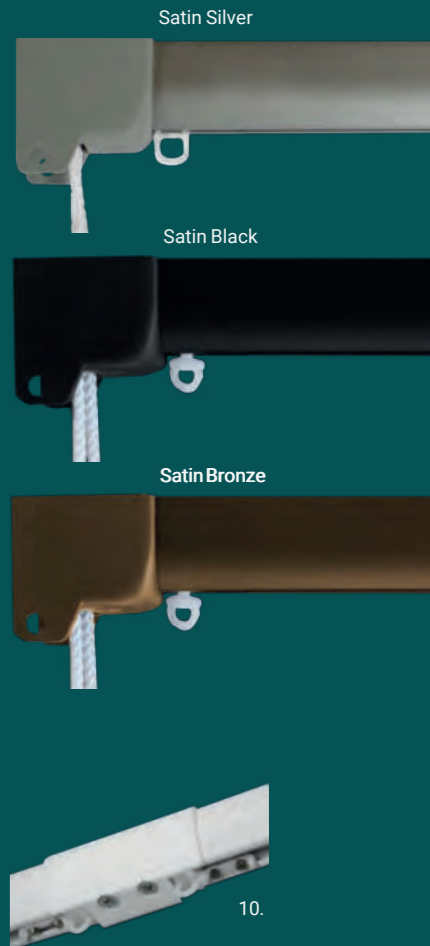

Stonehouse Extra Heavy Duty Uncorded

Extra heavy duty uncorded track which will take curtains up to 80kg. The curved styling makes it a very attractive option where heavy Surf curtains or long drops are required.

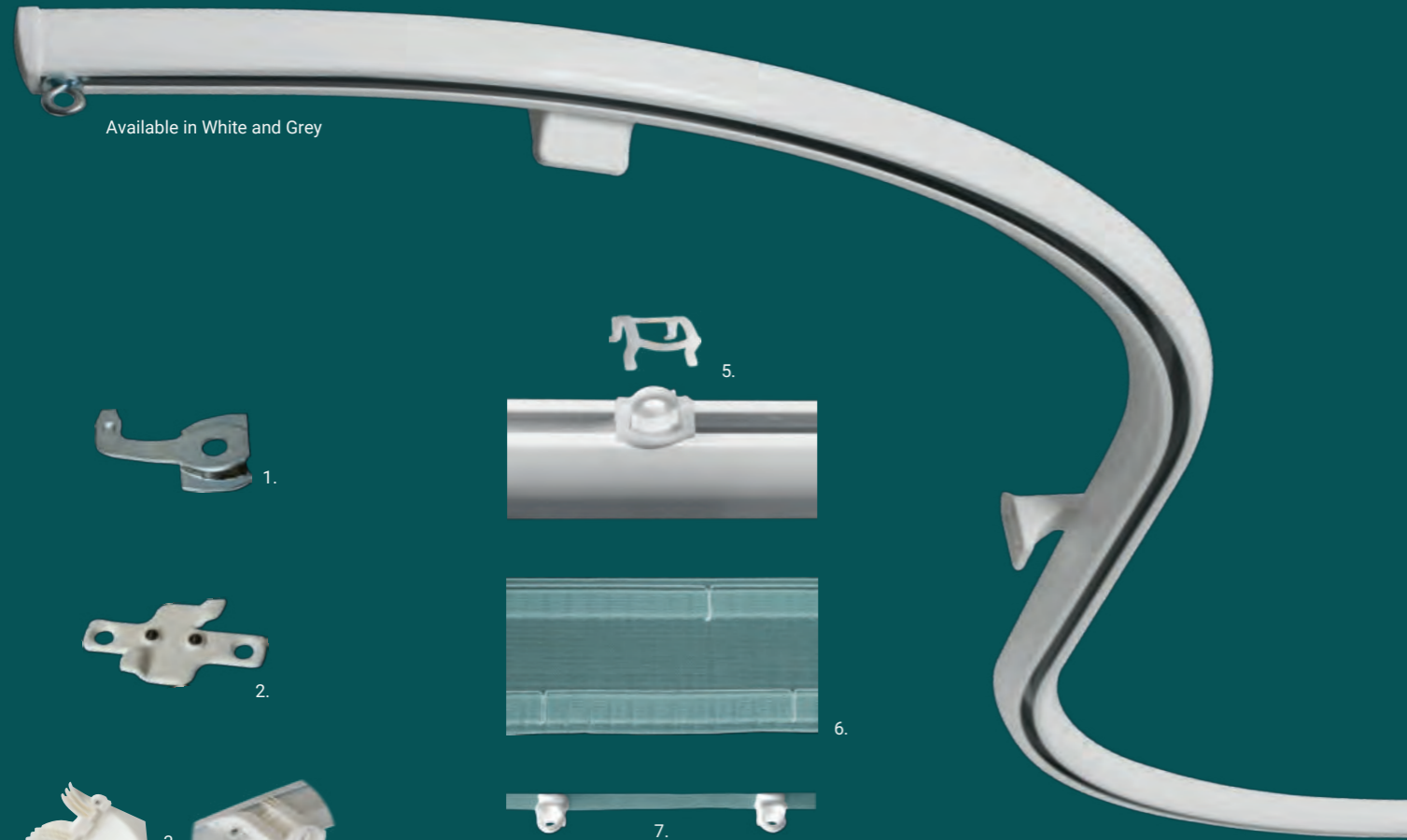

Available in White and Grey

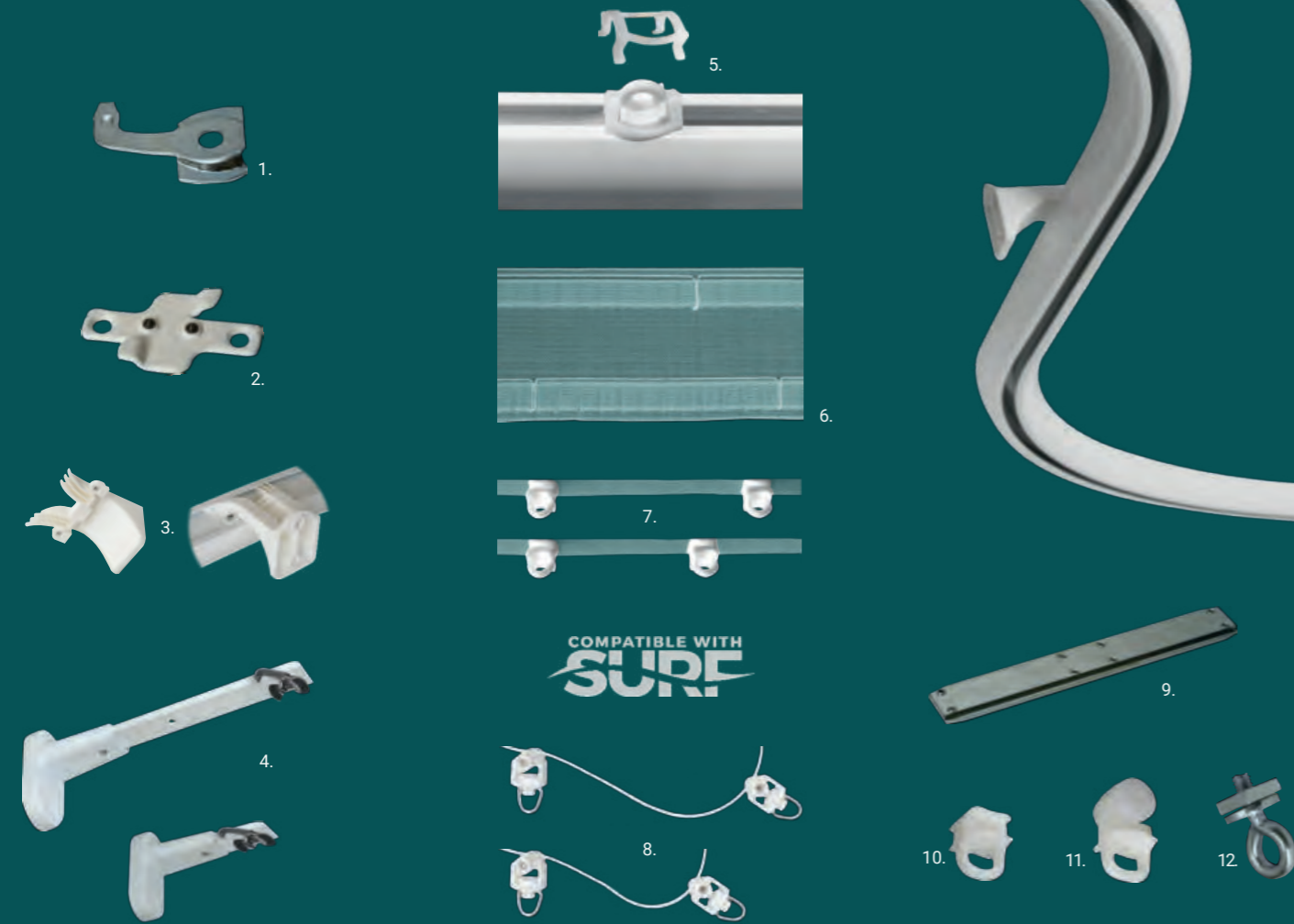

COMPATIBLE WITH SURF

Painswick Heavy Duty Uncorded

Heavy duty uncorded track with large roller gliders. It can be forward and reverse bent - excellent for bay windows and heavy curtains!



Only available in White

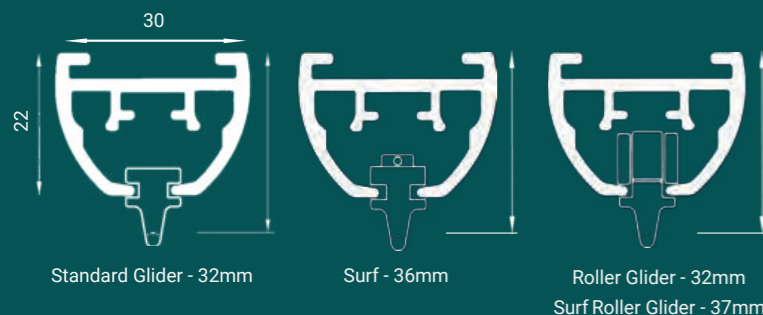
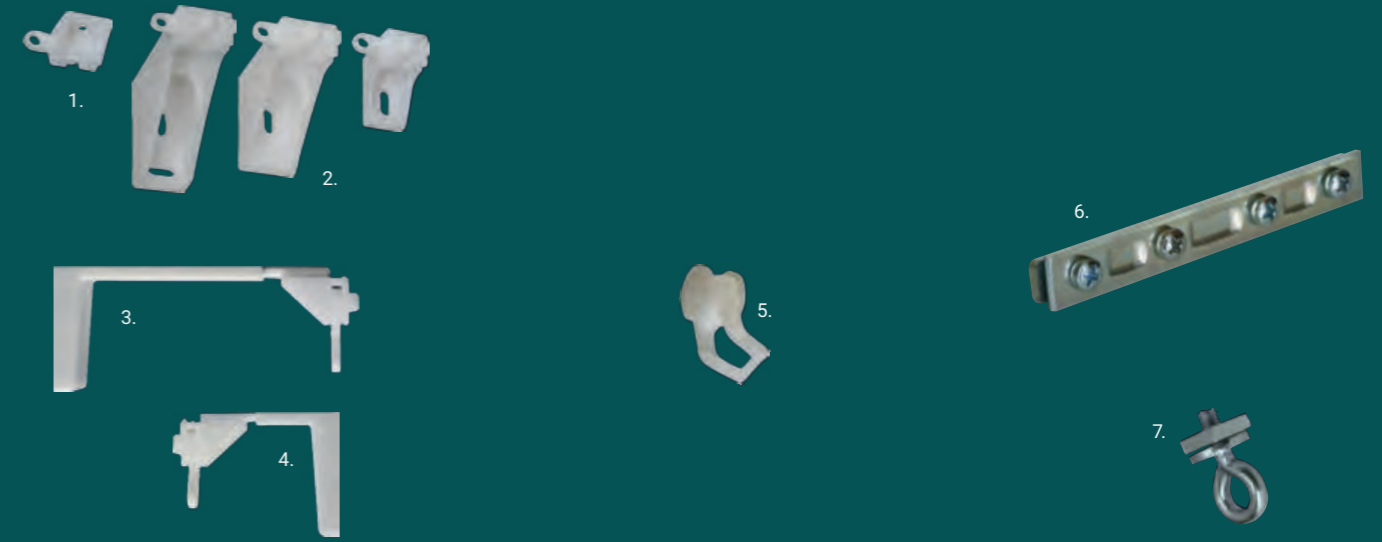

- 1. ST/TF Top Fix Clamp - up to 25kg
- 2. ST/HDTF Heavy Duty Top Fix Clamp - up to 80kg
- 3. ST/FFW/40 Face Fix Bracket - up to 25kg
- 4. ST/SAB Standard Adjustable Bracket 88 - 128mm
- 5. ST/LAB Long Adjustable Bracket 140 - 180mm
- 6. SUR/BRAKE Surf Brake
- 7. SUR/TAPE Surf Heading Tape
- 8. SUR/80 & SUR/60 Surf 80mm/ 60mm Glider Ribbon
- 9. SRO/80 & SRO/60 Surf 80mm/ 60mm Roller Gliders
- 10. ST/CB Connecting Bridge
- 11. WCG Wide Channel Glider
- 12. ST/RG Roller Glider
- 13. WCSE Wide Channel Screw Eye

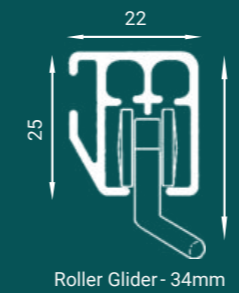
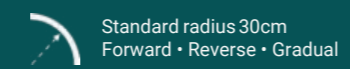

- 1. LLTF 3 sizes of Universal Leverlock Brackets
- 2. LLUF/42-66-84 Top Fix Leverlock Bracket
- 3. TRA/LBKTCOV Face Fixed L Bracket & Cover - Long 10.7cm
- 4. TRA/SBKTCOV Face Fixed L Bracket & Cover - Standard 6.5cm
- 5. BP/RG Roller Glider
- 6. BP/CB Connecting Bridge
- 7. WCSE Wide Channel Screw Eye

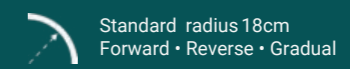

Berkeley Medium-Heavy Duty Uncorded

Medium-heavy duty uncorded track which can be forward and reverse bent - excellent for bay windows.

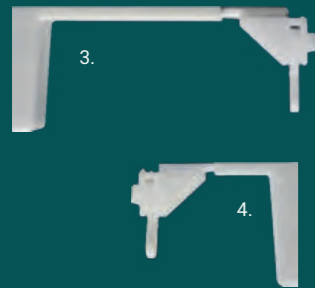
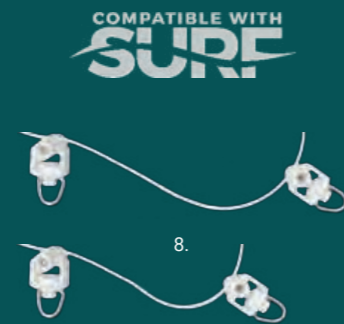
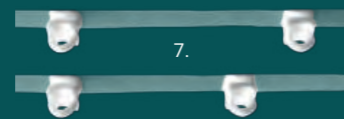

COMPATIBLE WITH
SURF

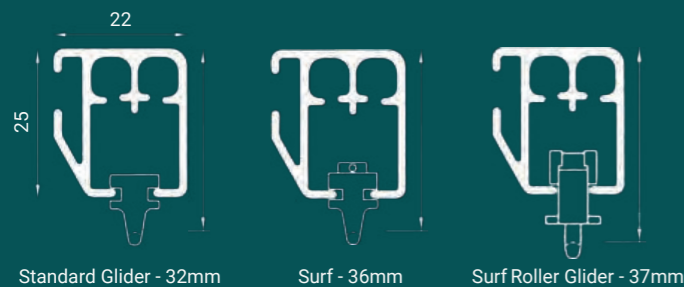

Standard Glider - 32mm Surf - 36mm Surf Roller Glider - 37mm

- | | |
|--------------------|---|
| 1. LLTF | Top Fix Leverlock Bracket |
| 2. LLUF/42-66-84 | 3 sizes of Universal Leverlock Brackets |
| 3. TRA/LBKTCOV | Face Fixed L Bracket & Cover - Long 10.7cm |
| 4. TRA/SBKTCOV | Face Fixed L Bracket & Cover - Standard 6.5cm |
| 5. SUR/BRAKE | Surf Brake |
| 6. SUR/TAPE | Surf Heading Tape |
| 7. SU/80 & SU/60 | Surf 80mm/ 60mm Glider Ribbon |
| 8. SRO/80 & SRO/60 | Surf 80mm/ 60mm Roller Gliders |
| 9. BP/CB | Connecting Bridge |
| 10. WCG | Wide Channel Glider |
| 11. WCTE | Wide Channel Twist Eye |

 Standard radius 18cm
Forward • Reverse • Gradual

Broadway Medium Duty Uncorded

Medium duty uncorded track with an attractive form especially suited to the contemporary Surf look!. Can be forward and reverse bent, excellent for bay windows.

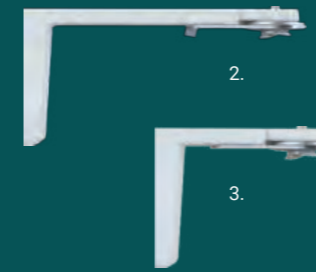
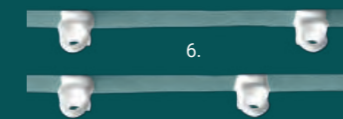
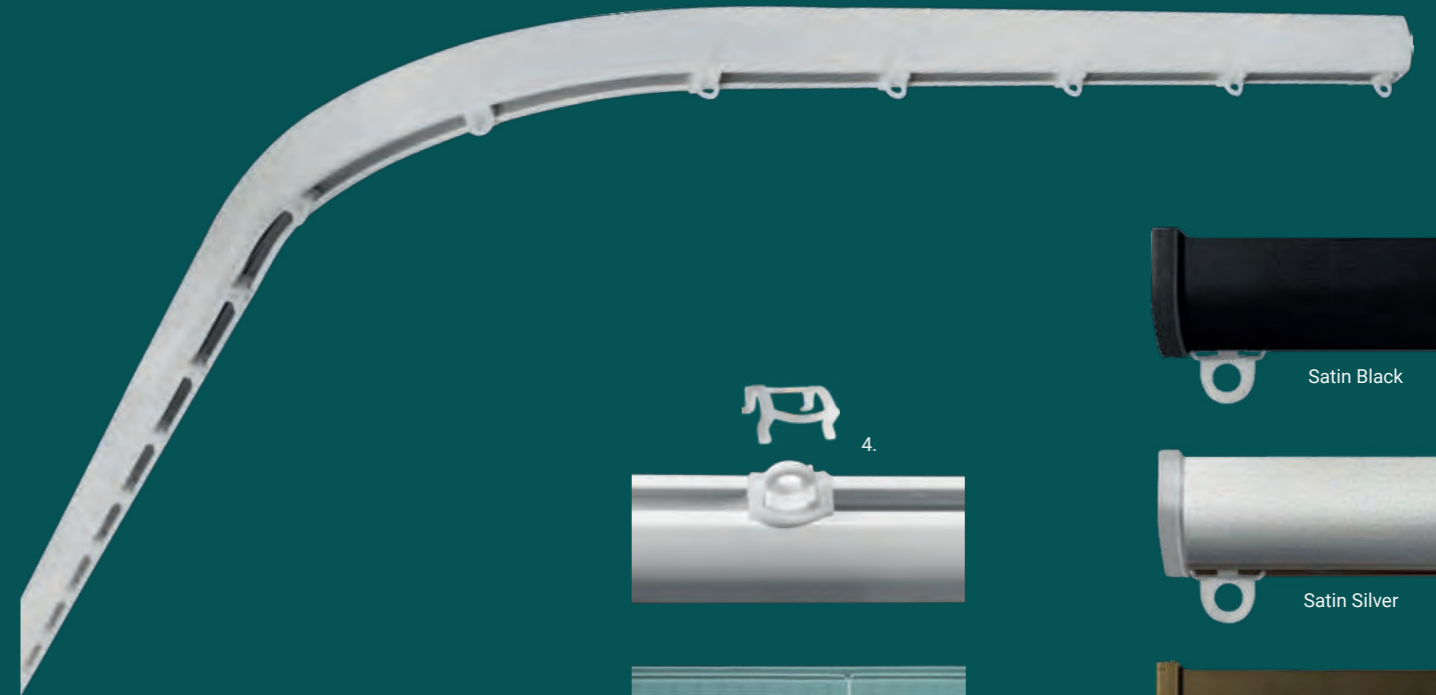

COMPATIBLE WITH
SURF

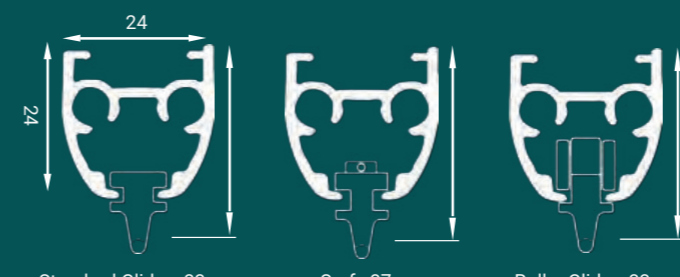

Standard Glider - 33mm Surf - 37mm Roller Glider - 33mm
Surf Roller Glider - 38mm

- | | |
|--------------------|---|
| 1. BR/TF | Top Fix Clamp |
| 2. TRA/LBKTCOV | Face Fixed L Bracket & Cover - Long 8cm |
| 3. TRA/SBKTCOV | Face Fixed L Bracket & Cover - Standard 3.8cm |
| 4. SUR/BRAKE | Surf Brake |
| 5. SUR/TAPE | Surf Heading Tape |
| 6. SU/80 & SU/60 | Surf 80mm/ 60mm Glider Ribbon |
| 7. SRO/80 & SRO/60 | Surf 80mm/ 60mm Roller Gliders |
| 8. BR/RG | Roller Glider |
| 9. WCG | Wide Channel Glider |
| 10. WCTE | Wide Channel Twist Eye |
| 11. BR/CB | Connecting Bridge |

 Standard radius 20cm
Forward • Reverse • Gradual

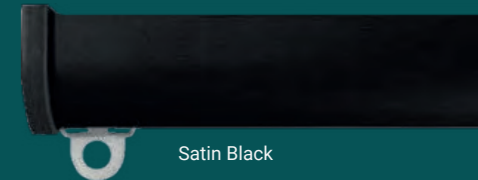

Satin Black



Satin Silver

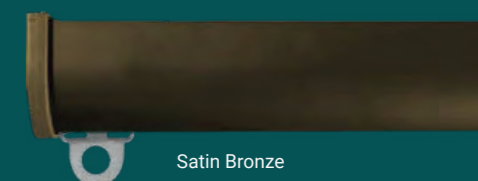

Satin Bronze



8. 9. 10. 11.



11.

Mini Broadway Light Duty Uncorded

The Mini Broadway uncorded is a discreet top fix track for light weight curtains and voiles.

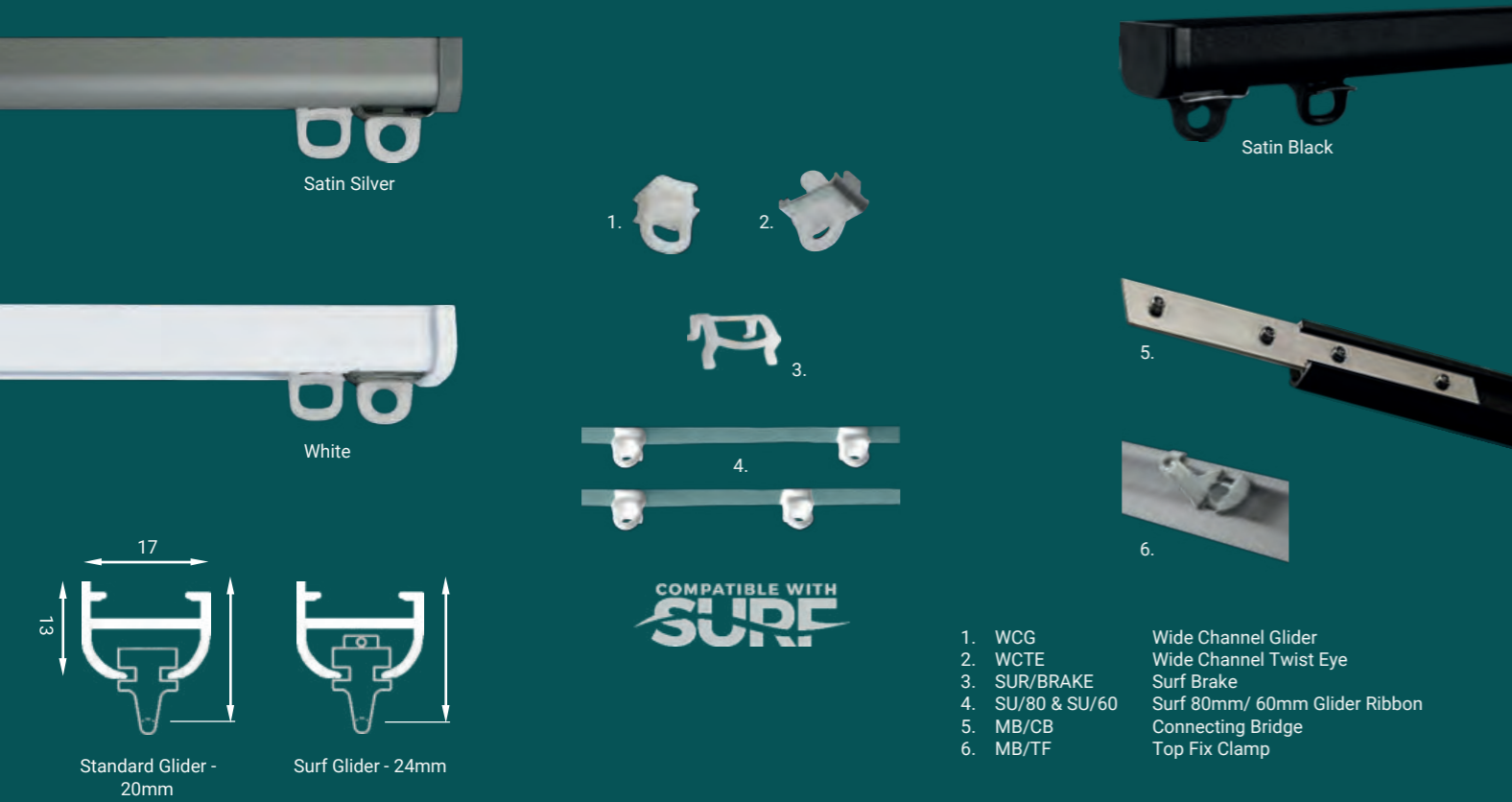

The Curve Medium Duty Uncorded - *Now available bent for bays!*

The Curve is a medium duty track that is often used with Surf curtains because of its clean form. Predominantly top fix, however face fix brackets are available upon request. Often used for large contract projects as it presents excellent value for money!

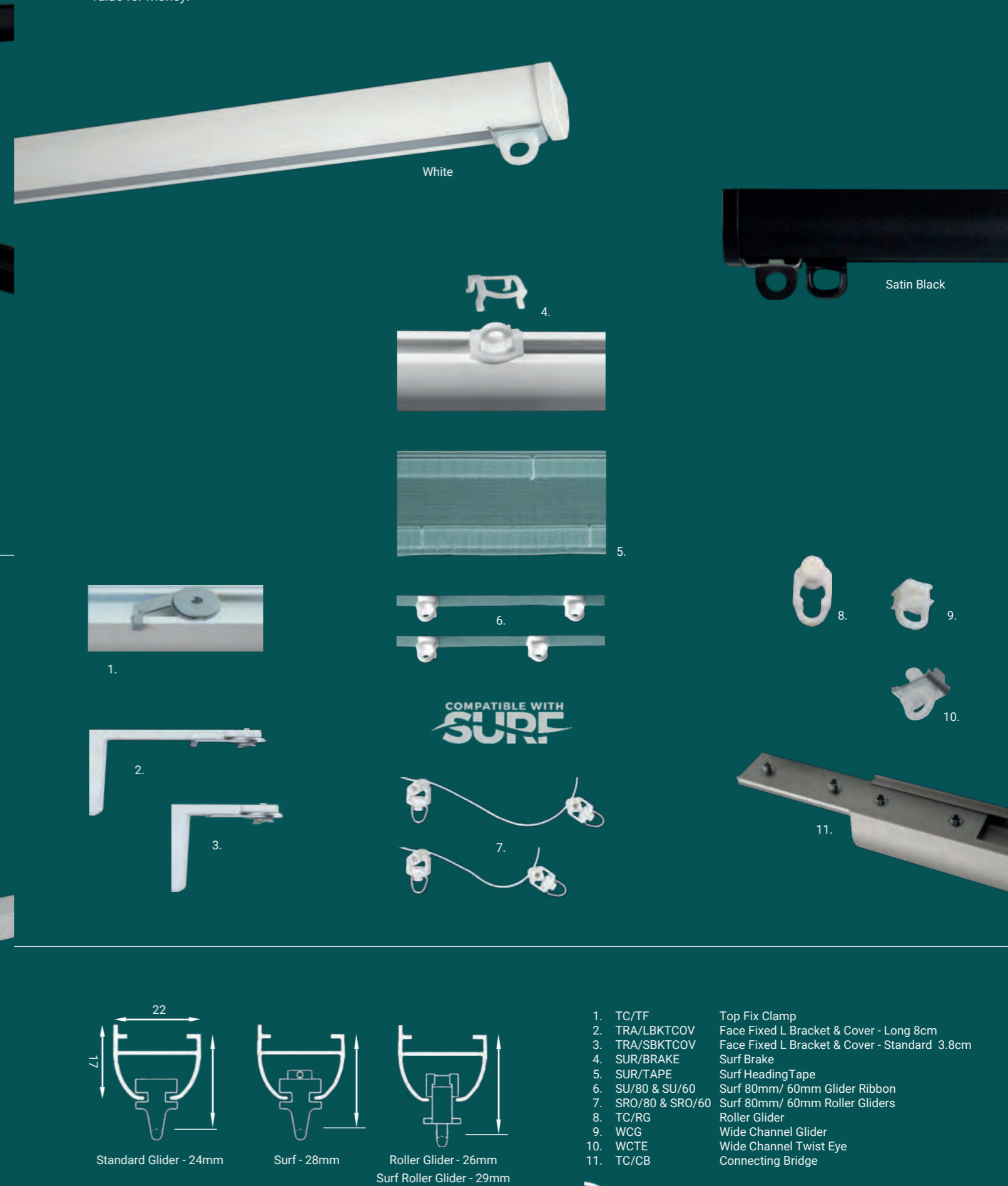

Burford Medium Duty Uncorded

A discreet top fix track for medium weight curtains and nets. Available in silver and white, this track is pre-drilled every 150mm for ease of fixing. It can also be fixed into concrete using special clamps.

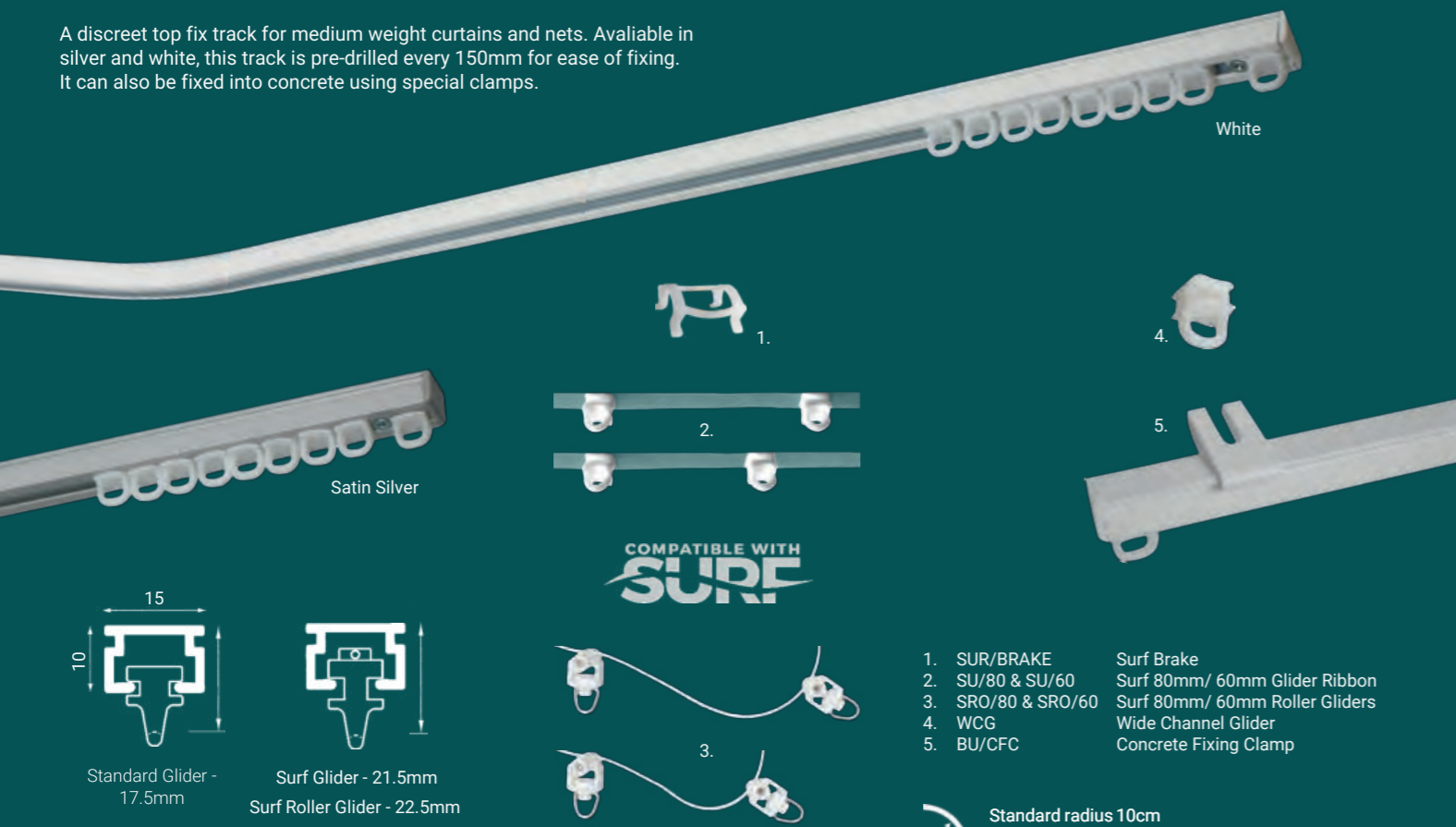

Standard radius 20cm
 Forward • Reverse • Gradual

Fixing Details

Berkeley/Painswick

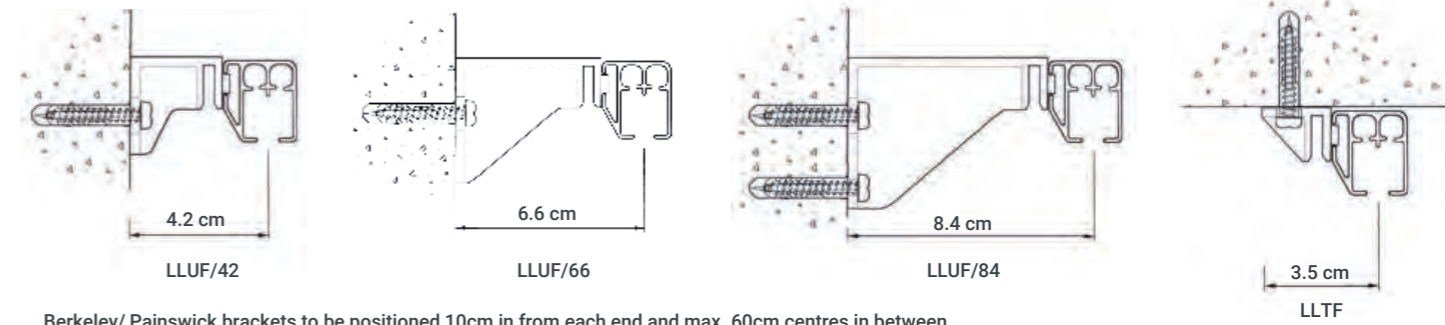

Berkeley/ Painswick brackets to be positioned 10cm in from each end and max. 60cm centres in between.

Broadway/ The Curve/ Mini Broadway

Burford

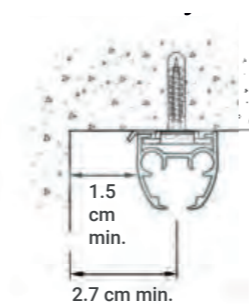

Broadway/ Curve top-fix ceiling brackets to be positioned 10cm from each end and max. 50cm centres in between.

Mini Broadway top-fix ceiling brackets to be positioned 10cm from each end and max. 30cm centres in between.

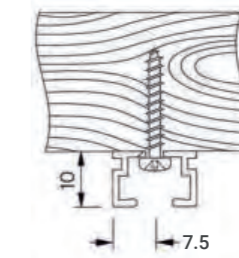

Use thin guage screws to fix through pre-drilled holes if fixing directly into wood.

Take care not to damage the glider channel by using a screw head that is too large.

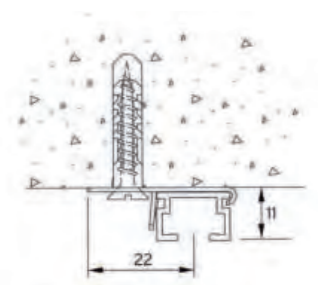

These Concrete Fixing Clamps (CFC) allow fixing into plasterboard etc as a larger screw can be used behind the track.

Burford CFC's to be positioned 10cm from each end and max 30cm centres in between.

Stonehouse

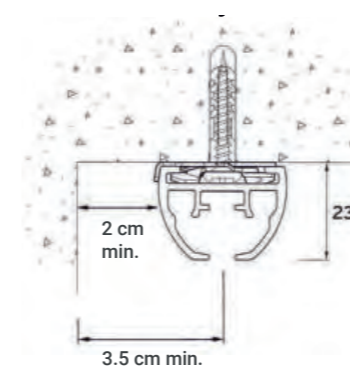

Standard Stonehouse top-fix ceiling brackets - max. capacity of 25kg curtain weight.

Position 10cm from end and max. 60cm centres in between.

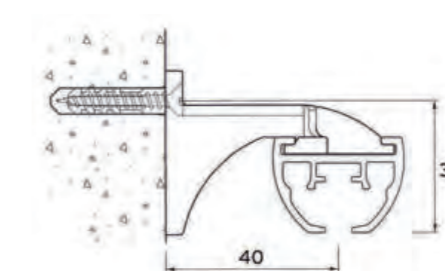

Standard Stonehouse face-fix wall brackets - max. capacity of 25kg curtain weight.

Position 10cm from end and max. 60cm centres in between.

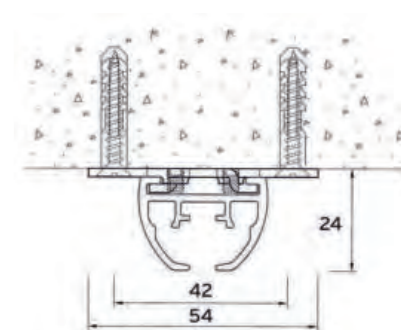

Heavy Duty Stonehouse top-fix ceiling brackets - max. capacity of 80kg curtain weight.

Position 10cm from end and max. 60cm centres in between.

Fixing centres may need to be decreased depending on the weight of the curtains and substratum that is being fixed into. If any doubt, please order more brackets at time of placing the order.

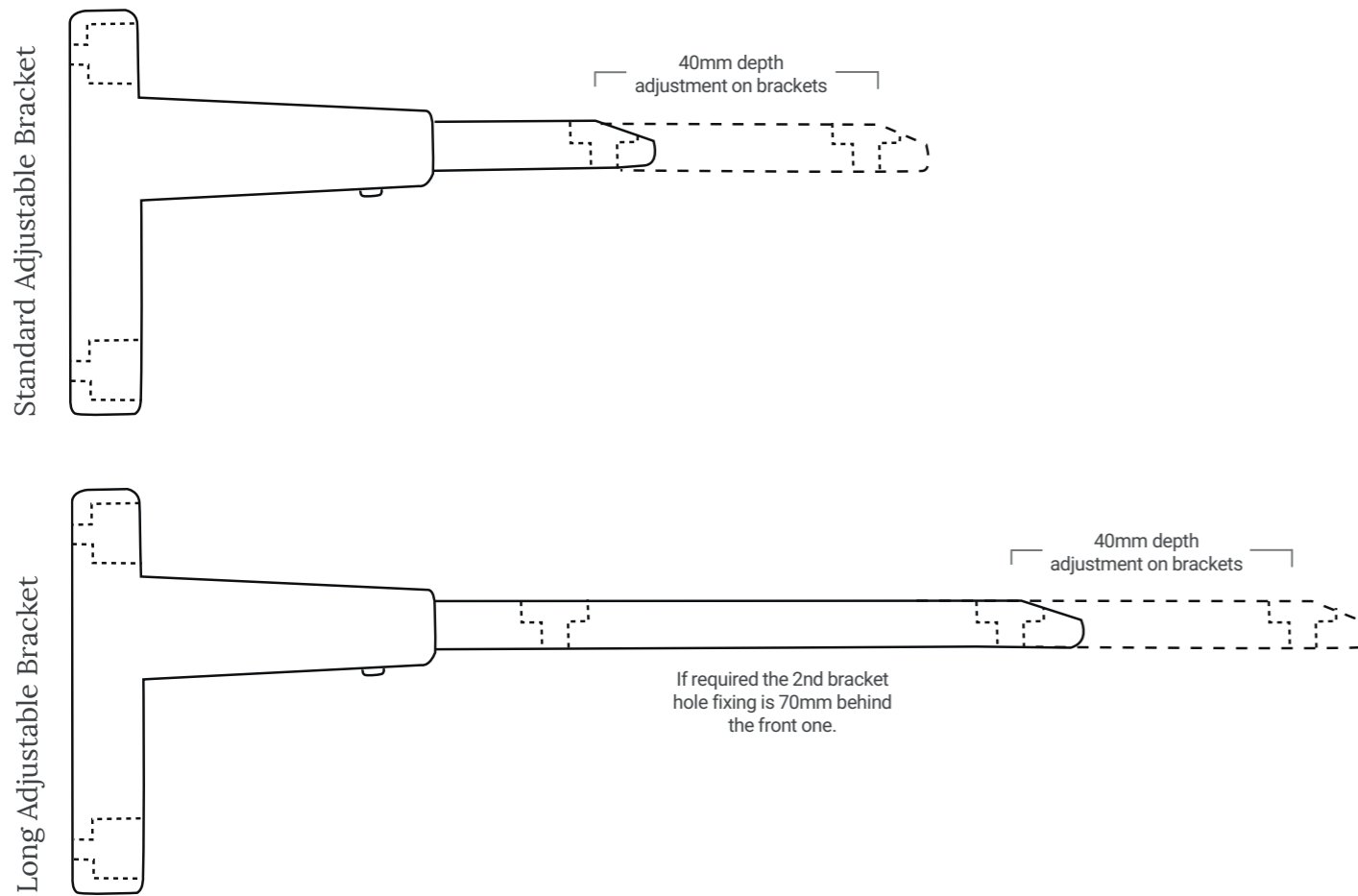

	Standard Adjustable Bracket (Wall to centre of track)	Long Adjustable Bracket (Wall to centre of track)
Stonehouse	75 - 115 mm	140 - 180 mm
	Face Fixed L Bracket & Cover - Standard (Wall to centre of track)	Face Fixed L Bracket & Cover - Long (Wall to centre of track)
Mini Broadway	40 mm	80 mm
Broadway	40 mm	80 mm
The Curve	40 mm	80 mm
Berkeley	67 mm	107 mm
Painswick	67 mm	107 mm



50mm Diameter poles only

Byzantine Bronze Ball reeded side

Byzantine Bronze Ball smooth side

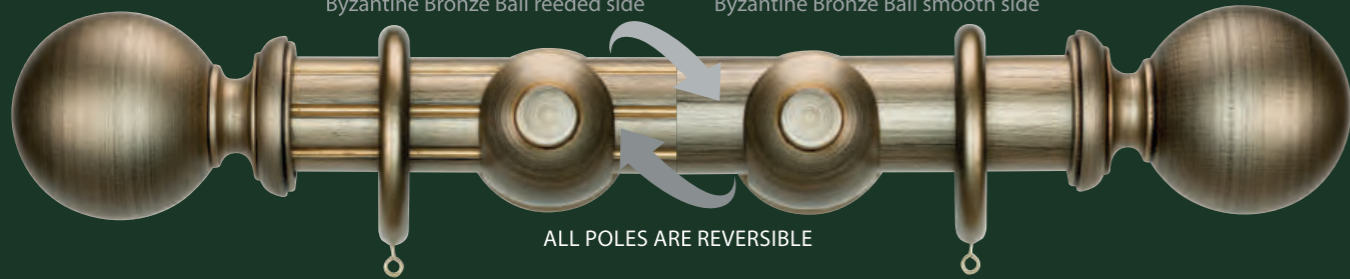

ALL POLES ARE REVERSIBLE

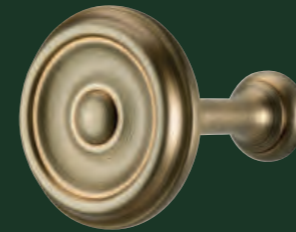

Travertine Urn reeded side

Travertine Urn smooth side

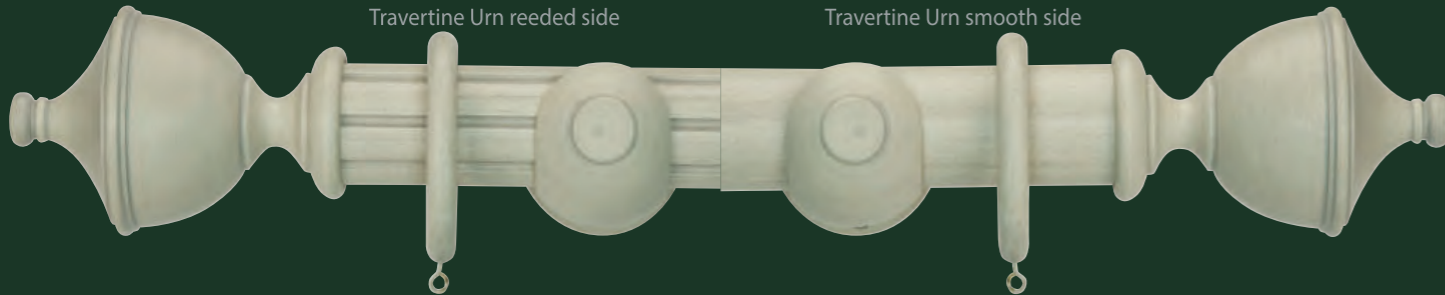

Venetian Gold Beehive reeded side

Venetian Gold Beehive smooth side

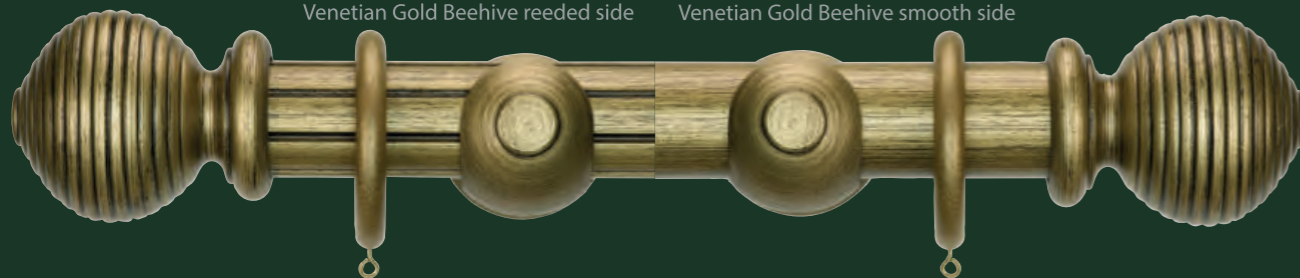

Baroque Cream Ball reeded side

Baroque Cream Ball smooth side

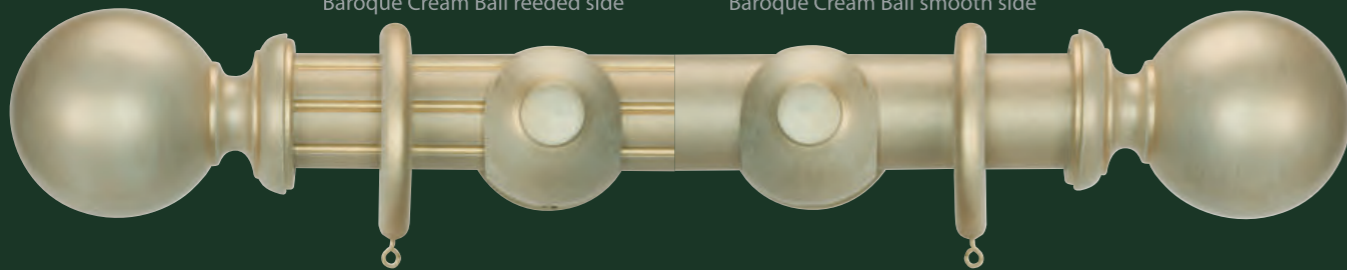

Chateau Grey Urn reeded side

Chateau Grey Urn smooth side

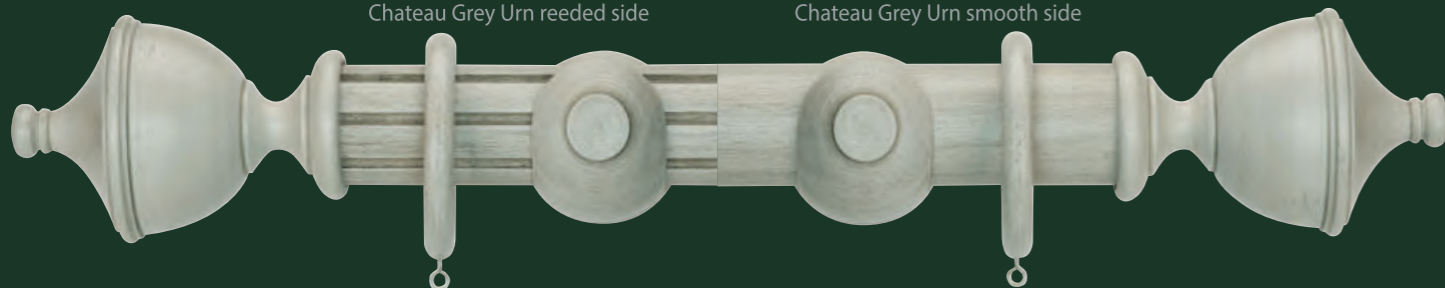

Dutch Silver Beehive reeded side

Dutch Silver Beehive smooth side

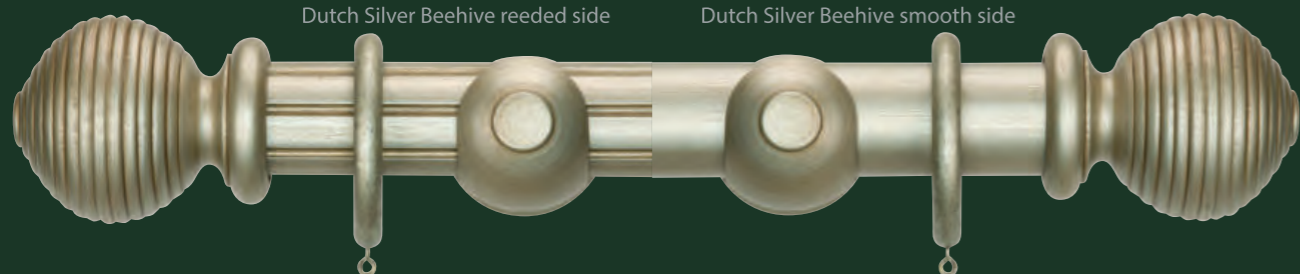

Corded poles are also available

Standard Set

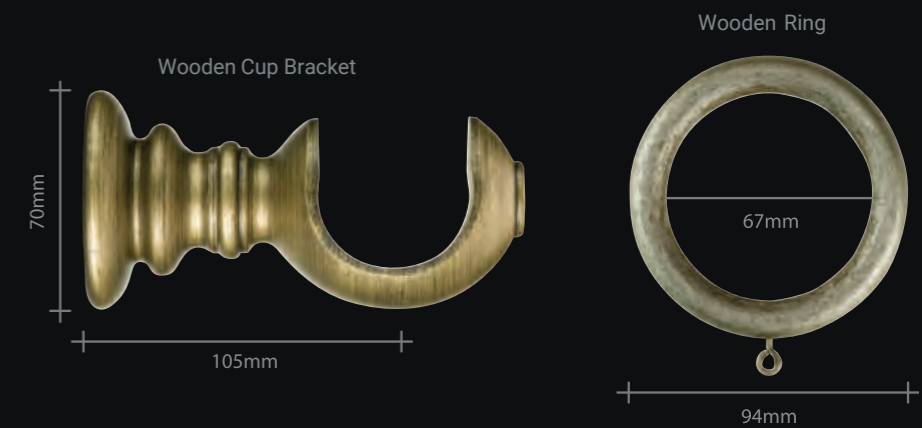

Options

Front of Holdback

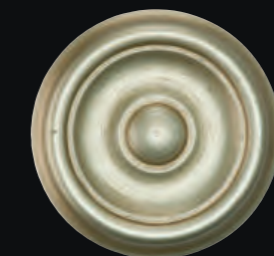

120mm

Side of Holdback



165mm

Front of Recess Bracket



85mm

Side of Recess Bracket



45mm



Chrome or Brass
Centre Bracket

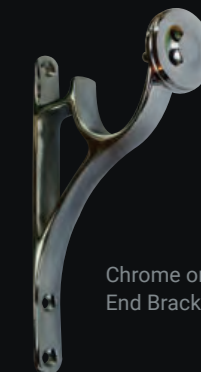

Chrome or Brass
End Bracket

Poles in 180cm and 240cm sets are supplied in 1 piece with 2 wooden cup brackets. Poles in 300cm, 360cm and 480cm sets are supplied in 2 pieces with a joining screw and 3 wooden cup brackets. Poles sets include rings @10/m. Extra rings available in packs of 4.

Brass or chrome brackets are available as an up-charge. Holdbacks are sold individually. These Poles are a natural wood hand-finished product so some colour variations may occur.

Cut-to-length service available

Avant-garde.



Heirloom Wood Poles

The Avant-garde collection consists of three luxury wood pole ranges, each curated to represent a timeless style: Revival, Classical and Retro.

www.avantgarde-poles.co.uk

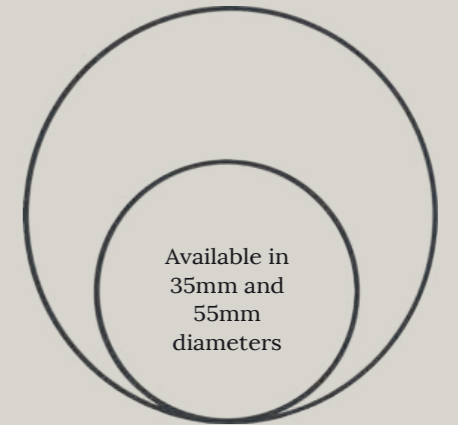

Revival



Sandalwood

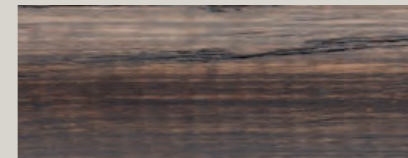

Chestnut

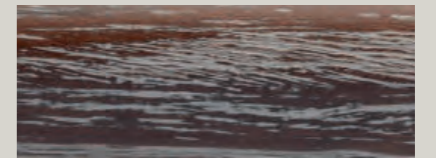

Anise



Ash



Chalk



Gypsum

Classical

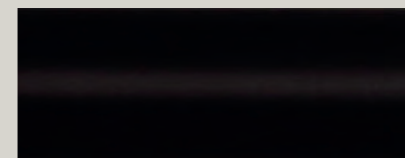

Ebony



Ivory



Antique Gold (Finial Finish Only)

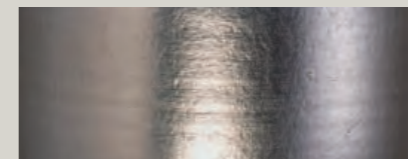

Platinum (Finial Finish Only)

Retro



Ginger

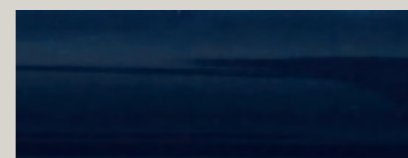

Inked

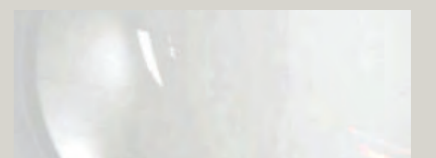

Acrylic

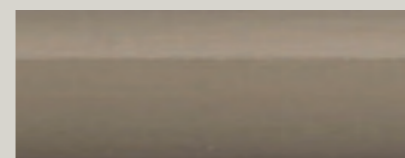

Stone

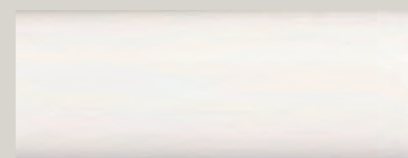

Porcelain



Credit: Simply Living
Credit: MAK Interiors

Finials



Floral



Ribbed Ball



Urn



Swirling Ball



Shown actual
size in 45mm and
55mm diameters



Plain Ball



Classico

Wood

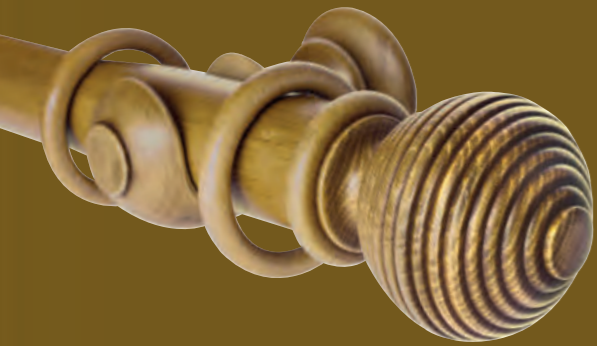

Ribbed Ball shown in Light Oak



Plain Ball shown in Antique Pine



Ribbed Ball shown in Cognac



Available in 45mm and 55mm diameters



Urn shown in Medium Oak

Painted



Ribbed Ball shown in Antique Pewter



Classico shown in Black Pearl

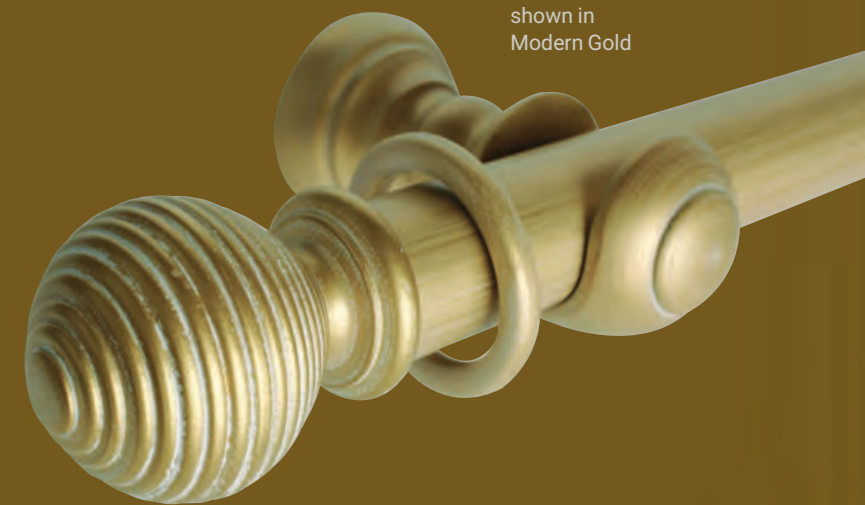

Ribbed Ball shown in Modern Gold

Painted

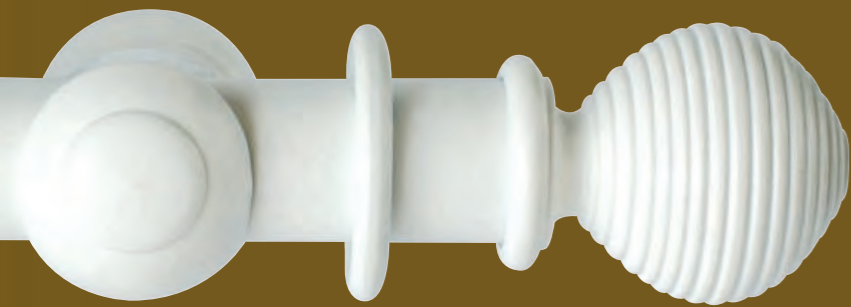

Ribbed Ball
shown in Soft
White

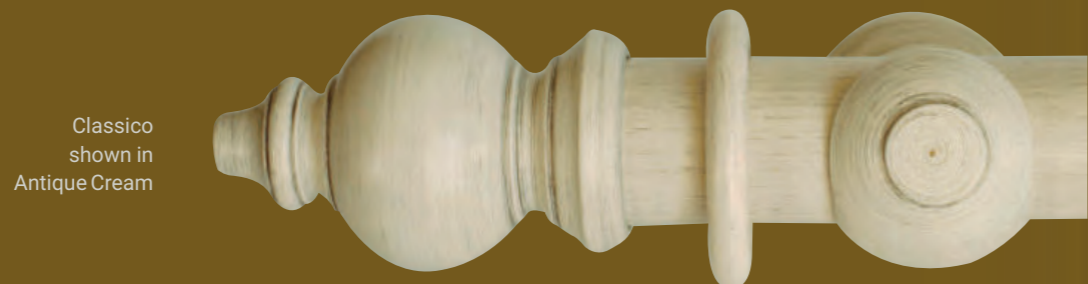

Classico
shown in
Antique Cream

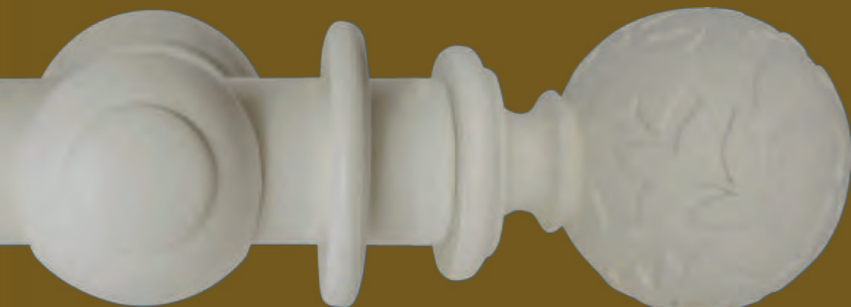

Floral shown in
Soft Cream



Floral shown in
Antique Ivory



Urn shown in
Antique Cream

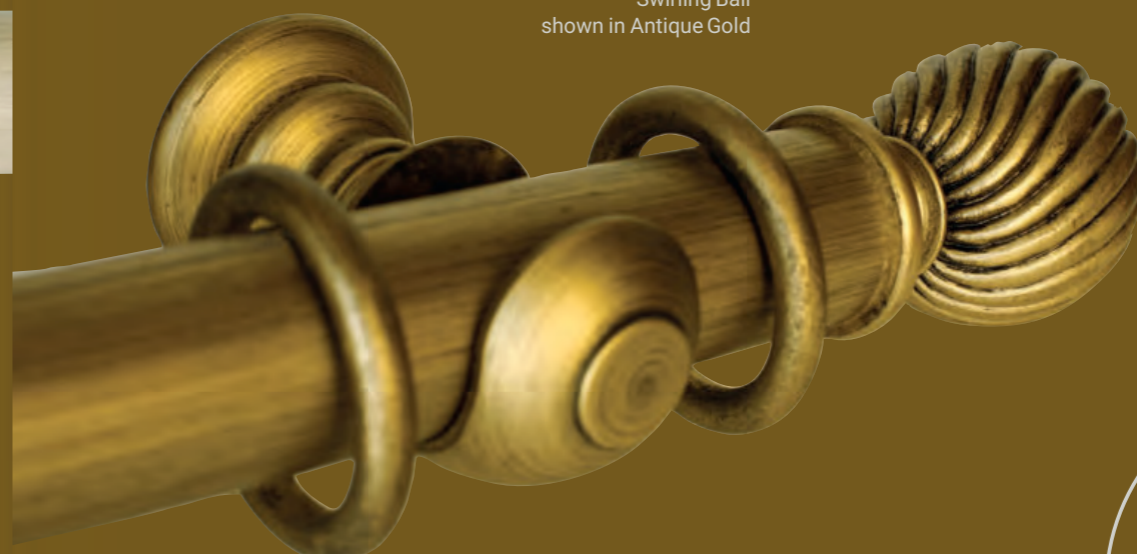

Swirling Ball
shown in Antique Gold

Available
cut-to-length at
no extra charge



Available in
45mm and 55mm
diameters

Product descriptions are trade terms and do not necessarily indicate composition or material of the product.



Antique Gold



Modern Gold



Antique Cream



Antique Ivory

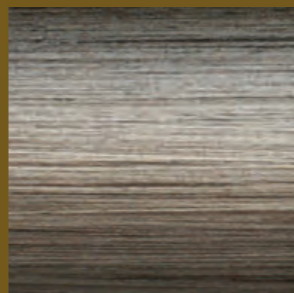

Antique Pewter

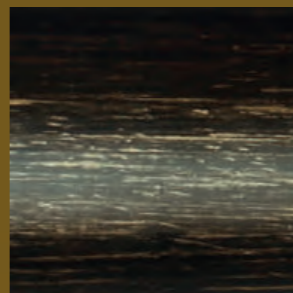

Black Pearl

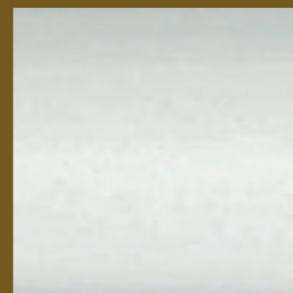

Soft White



Soft Cream

Cording



All poles can be corded, with brass or chrome railway track and underclip brackets.

Accessories

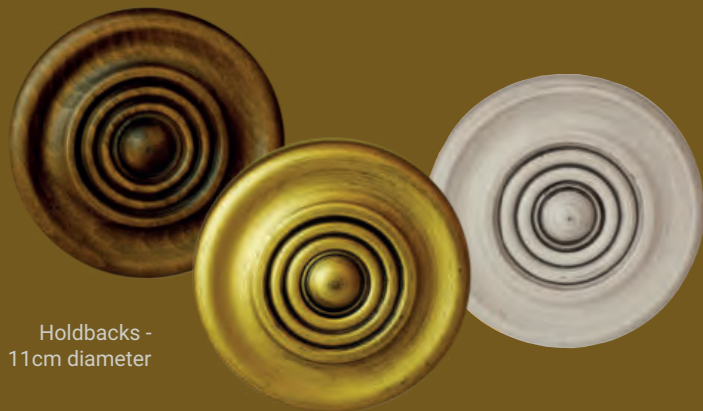

Holdbacks -
11cm diameter



Recess
Brackets



Light Oak



Medium Oak



Antique Pine



Cognac

Wood Venetians



Credit: Pentagon Group UK
www.pentagongroup.uk.com

High Quality Basswood Blinds

- Beautiful soft colour palette.
- Available in 25mm/35mm/50mm slat width.
- Extra wide blind widths - up to 2900 wide, with drop up to 3100mm!
- Special magnetic clip on colour-matched valance.
- Optional colour-matched mitred valance returns available.
- Free Colour swatch available on request.















As with all wood products, variations in grain, texture and colour along with some slight warpage may occur. These are natural characteristics of real hardwood blinds.

Standard Specifications for all three slat sizes:

- RH lift control (unless otherwise specified) with cord lock mechanism.
- LH tilt controls (unless otherwise specified) dual cords.
- Controls can be fitted to one side if required; minimum blind width for this is 420mm.
- Minimum width 400mm x 400mm drop.
- Maximum width 2900mm x 3100mm drop.

- Magnetic 'C' shape colour co-ordinated valance.
- Mitred returns upon request at no additional cost.
- Universal Swivel brackets are standard - box brackets available at no extra cost.
- 2 x Child safety cleats per blind

Profile Comparison Chart

Track	Profile	Description	Colours	Similar Tracks	Cording options		Bending	Glider options				Bracket Options		Guidance on Weight							
					Uncorded	Corded	Yes/No	Standard	Rollers	Surf 60mm	Surf 80mm	Top Fix	Face Fix	Light	Light - Medium	Medium	Medium to Heavy	Heavy	Extra Heavy		
Distinction 20 Uncorded only		20mm diameter hand drawn pole, often used for Sheers on wide windows, or as back pole on double pole set.	11 colours	1003 Uncorded Mini Metropole (closest equivalent is 23mm).	👍		👍	👍	👍	👍	👍	👍	👍	👍	👍	👍	👍	👍	👍	👍	
Distinction 28 Corded & Uncorded		28mm diameter pole, great for bay windows or bi-fold doors; no obstructions from brackets as gliders sit under the poles.	11 Colours	6130 Uncorded Metropole/6120 Corded Metropole (closest equivalent is 30mm).	👍	👍	👍	👍	👍	👍	👍	👍	👍	👍	👍	👍	👍	👍	👍	👍	
Distinction 34 Corded & Uncorded		34mm High flat profile, great for bay windows or bi-fold doors; no obstructions from brackets as gliders sit under the poles.	11 Colours	6100 Uncorded Metroflat (closest equivalent is 36mm). SG do not offer corded option.	👍	👍	👍	👍	👍	👍	👍	👍	👍	👍	👍	👍	👍	👍	👍	👍	
Stonehouse Corded & Uncorded		Extra Heavy Duty Track, will take curtains up to 80kg and 15 metres long. (Must use heavy duty top fix brackets if very heavy curtains).	White/ Grey	No SG equivalent?	👍	👍	👍	👍	👍	👍	👍	👍	👍	👍	👍	👍	👍	👍	👍	👍	
Painswick Corded & Uncorded		Heavy Duty track with forward projected roller gliders so that the curtain can upstand the front of track; excellent for bay windows and heavy curtains.	White	SG 3900	👍	👍	👍		👍			👍	👍	👍	👍	👍	👍	👍	👍	👍	
Berkeley Corded & Uncorded		Medium-Heavy duty track, excellent for bay windows.	White	SG 3000	👍	👍	👍	👍			👍	👍	👍	👍	👍	👍	👍	👍	👍	👍	
Broadway Corded & Uncorded		Medium duty track, ideal for Bay windows. Often used with Surf (Wave) curtains because it's attractive looking. Predominantly top fixed but can have face fix brackets at extra charge.	White, Silver, Bronze, Black	SG 3840	👍	👍	👍	👍	👍	👍	👍	👍	👍	👍	Surcharge	👍	👍	👍	👍	👍	Uncorded
Burford Uncorded only		Discreet top fix curtain track for medium weight curtains and nets. Pre-drilled every 150mm for fixing through track, or can use concrete fixing clamps to fix to plasterboard etc	White, Silver	No SG equivalent?	👍		👍	👍			👍	👍	👍	👍	👍	👍	👍	👍	👍	👍	👍
Woodstock Uncorded only		Discontinued		SG 1080																	
The Curve Uncorded only		Medium duty track for medium weight curtains. Often used with Surf (Wave) curtains because it's attractive looking. Predominantly top fixed, but can have face fix brackets at an extra charge.	White, Black	SG 6010	👍		👍	👍	👍	👍	👍	👍	👍	👍	Surcharge	👍	👍	👍	👍	👍	👍
Mini Broadway Uncorded only		Good looking discreet top fix track for medium weight curtains. (No face fix option).	White, Silver, Black	No SG equivalent?	👍			👍		👍	👍	👍	👍		👍	👍	👍	👍	👍	👍	👍
Somfy Motorised		Battery, Plug and Play and Hard Wire options for Audio Visual. Bendable track. Available with Surf (Wave) and roller gliders.	White	SG5600 (No SG battery option?)			👍	👍	👍	👍	👍	👍	👍	👍	👍	👍	👍	👍	👍	👍	👍